

---

***National Nanotechnology Coordinated  
Infrastructure (NNCI)***

***Research and Education Highlights***

***Year 5 (October 2019 – September 2020)***



# Table of Contents

---

<b>National Science Foundation Big Ideas</b>	
Quantum Leap	3
Understanding the Rules of Life	33
Growing Convergence Research	61
Harnessing the Data Revolution	93
Future of Work at the Human-Technology Frontier	98
Navigating the New Arctic	104
Mid-Scale Research Infrastructure	107
NSF INCLUDES	109
<b>National Academy of Engineering Grand Challenges</b>	
Make Solar Energy Economical	113
Engineer the Tools of Scientific Discovery	121
Provide Access to Clean Water	124
Other NAE Grand Challenges	128
<b>NNI Signature Initiatives</b>	134
<b>Other National Research Priorities</b>	139

---

# ***NSF-Quantum Leap***

# Experimental Demonstration of Memory Enhanced Quantum Communication

The ability to communicate quantum information over long distances is of central importance in quantum science and engineering. Although some applications of quantum communication such as secure quantum key distribution are already being successfully deployed, their range is currently limited by photon losses and cannot be extended using straightforward measure-and-repeat strategies without compromising unconditional security. Quantum repeaters, which utilize intermediate quantum memory nodes and error correction techniques, are needed to extend the range of quantum channels. A joint Harvard/MIT team use a single solid-state spin memory integrated in a nanophotonic diamond resonator to implement asynchronous photonic Bell-state measurements, which are a key component of quantum repeaters. In a proof-of-principle experiment, they demonstrate high-fidelity operation that effectively enables quantum communication at a rate that surpasses the ideal loss-equivalent direct-transmission method while operating at megahertz clock speeds. These results represent a crucial step towards practical quantum repeaters and large-scale quantum networks.

Bhaskar, M. K.; Riedinger, R.; Machielse, B.; Levonian, D. S.; Nguyen, C. T.; Knall, E. N.; Park, H.; Englund, D.; Loncar, M.; Sukachev, D. D.; Lukin, M. D.; Harvard University

This work was supported by NSF NNCI Award ECCS-1541959. *Nature* 580, 60–64 (2020).

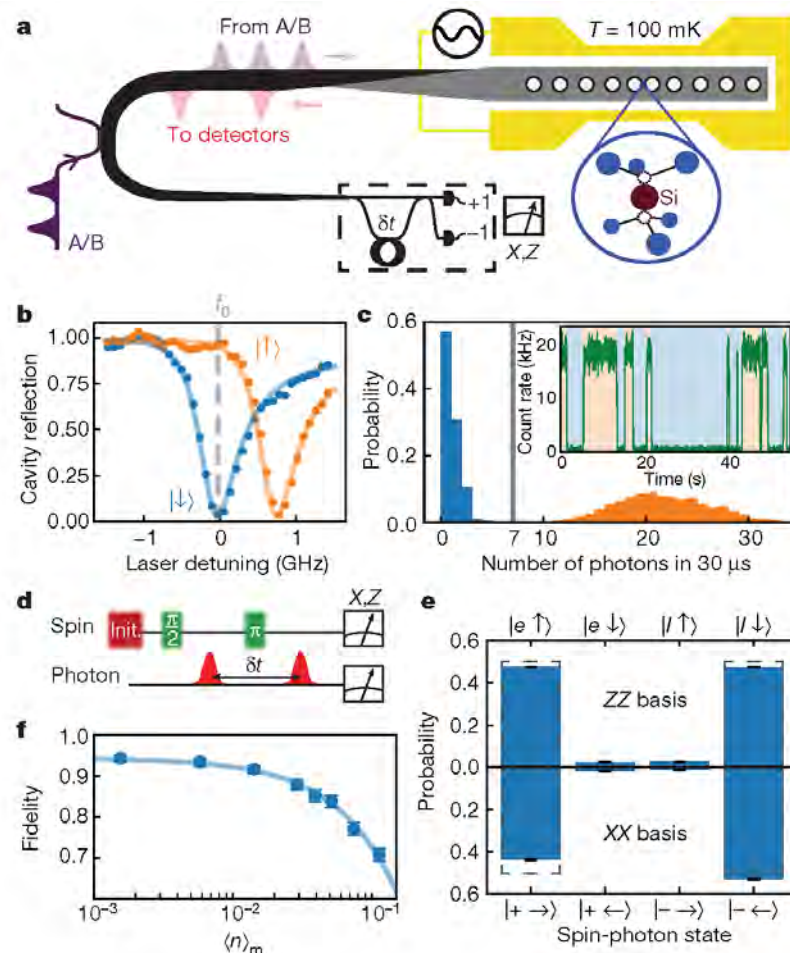

National Research Priority: NSF-Quantum Leap



# Strange Metal in Magic-Angle Graphene with near Planckian Dissipation:

Recent experiments on magic-angle twisted bilayer graphene have discovered correlated insulating behavior and superconductivity at a fractional filling of an isolated narrow band. The team at MIT has also shown that magic angle bilayer graphene exhibits another hallmark of strongly correlated systems—a broad regime of T-linear resistivity above a small density-dependent crossover temperature — for a range of fillings near the correlated insulator. This behavior is reminiscent of similar behavior in other strongly correlated systems, often denoted “strange metals,” such as cuprates, iron pnictides, ruthenates, and cobaltates, where the observations are at odds with expectations in a weakly interacting Fermi liquid. They have extracted a transport “scattering rate,” which satisfies a near Planckian form that is universally related to the ratio of  $kBT = \hbar$ . Their results establish magic-angle bilayer graphene as a highly tunable platform to investigate strange metal behavior, which could shed light on this mysterious ubiquitous phase of correlated matter.

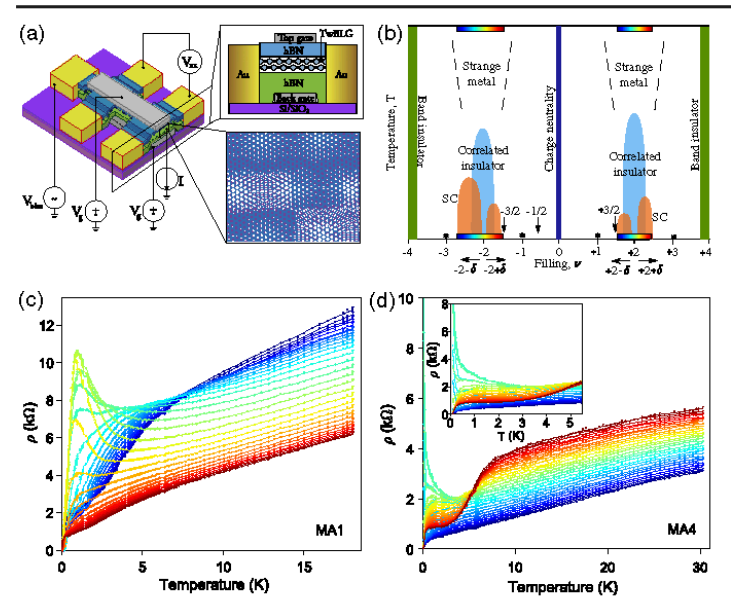

Cao, Yuan; Chowdhury, Debanjan ; Rodan-Legrain, Daniel ; Rubies-Bigorda, Oriol; Watanabe, Kenji; Taniguchi, Takashi; Senthil, T. ; Jarillo-Herrero, Pablo, Dept. of Physics, MIT, Dept. of Physics, Cornell University, National Institute for Materials Science, Japan.

This work was supported by NSF NNCI Award ECCS-1541959. *Phys. Rev. Lett.*, 124 (7), 076801 (2020).

National Research Priority: NSF-Quantum Leap

# Coherent control of a hybrid superconducting circuit made with graphene-based van der Waal heterostructures

Quantum coherence and control is foundational to the science and engineering of quantum systems. In van der Waals materials, the collective coherent behaviour of carriers has been probed successfully by transport measurements. However, temporal coherence and control, as exemplified by manipulating a single quantum degree of freedom, remains to be verified. Here the team demonstrates such coherence and control of a superconducting circuit incorporating graphene-based Josephson junctions. Furthermore, we show that this device can be operated as a voltage-tunable transmon qubit, whose spectrum reflects the electronic properties of massless Dirac fermions travelling ballistically. In addition to the potential for advancing extensible quantum computing technology, our results represent a new approach to studying van der Waals materials using microwave photons in coherent quantum circuits.

Joel I-Jan Wang, Daniel Rodan-Legrain, Landry Bretheau, Daniel L. Campbell, Bharath Kannan, David Kim, Morten Kjaergaard, Philip Krantz, Gabriel O. Samach, Fei Yan, Jonilyn L. Yoder, Kenji Watanabe, Takashi Taniguchi, Terry P. Orlando, Simon Gustavsson, Pablo Jarillo-Herrero and William D. Oliver; Massachusetts Institute of Technology.

This work was supported by NSF NNCI Award ECCS-1541959. *Nature Nanotechnology*, 14, 120-125 (2019).

National Research Priority: NSF-Quantum Leap

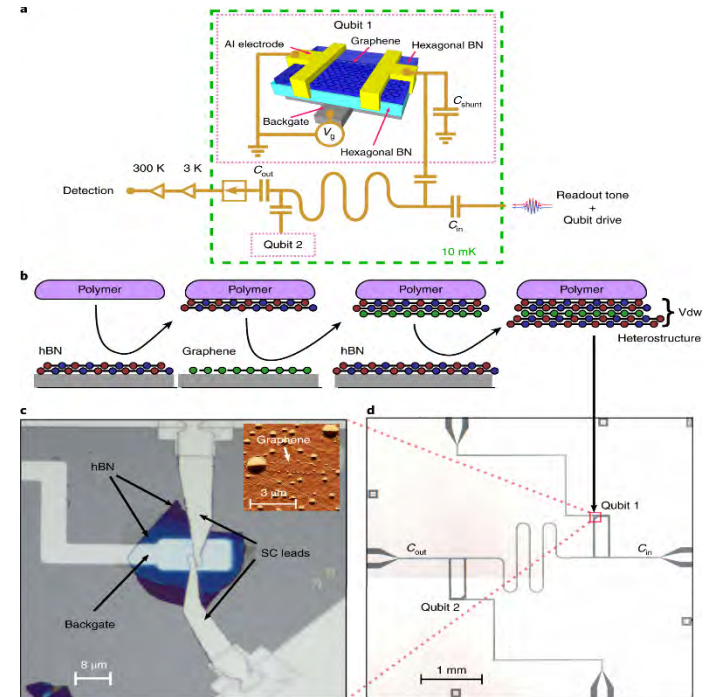

**Figure 1:** a, Schematic of the hBN-encapsulated S-G-S junctions embedded in a cQED system. b, Assembly of vdW heterostructures using a dry polymer-based pick-up and transfer technique. c, Optical micrograph of the graphene transmon qubit. SC, superconducting. Inset, atomic force microscopy image of the encapsulated graphene before making electrical contact to the superconducting electrodes. d, Qubit chip made of high-quality aluminium. Each shunting capacitor is cut out at the corner (red box; see c) to host the assembled vdW stack. Bonding pads on the top and bottom of the chip are used for backgate control.

# Broadband electro-optic frequency comb generation in a lithium niobate microring resonator

Optical frequency combs consist of equally spaced discrete optical frequency components and are essential tools for next generation quantum optical communication, precision metrology, timing and spectroscopy. Here the Loncar team has realized an integrated EO comb generator in a thin-film lithium niobate photonic platform that features a large EO response, ultralow optical loss and highly co-localized microwave and optical fields, while enabling dispersion engineering. Their measured EO comb spans more frequencies than the entire telecommunications L-band (over 900 comb lines spaced about 10 gigahertz apart), and they show that future dispersion engineering can enable octave-spanning combs. Furthermore, they demonstrate the high tolerance of our comb generator to modulation frequency detuning, with frequency spacing finely controllable over seven orders of magnitude (10 hertz to 100 megahertz), and they use this feature to generate dual-frequency combs in a single resonator.

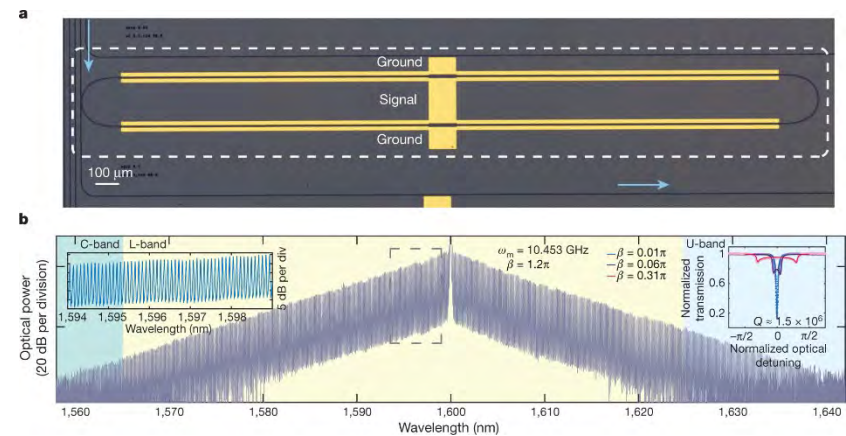

**Figure 1:** a, Micrograph of a fabricated lithium niobate microring resonator (a shorter device is shown here for illustration purposes). The black lines are etched optical waveguides and the yellow regions are gold microelectrodes.

Mian Zhang, Brandon Buscaino, Cheng Wang, Amirhassan Shams-Ansari, Christian Reimer, Rongrong Zhu, Joseph M. Kajm, and Marko Loncar; Harvard University.

This work was supported by NSF NNCI Award ECCS-1541959. *Nature Comm.* (2019); *Appl. Phys. Lett.*, 115 12108 (2019)

*National Research Priority: NSF-Quantum Leap*



# High-purity orbital angular momentum states from a visible metasurface laser

Orbital angular momentum (OAM) from lasers holds promise for compact, at-source solutions for applications ranging from imaging to communications. However, conjugate symmetry between circular spin and opposite helicity OAM states ( $\pm\ell$ ) from conventional spin-orbit approaches has meant that complete control of light's angular momentum from lasers has remained elusive. Here, The Capasso Group reports a metasurface-enhanced laser that overcomes this limitation. We demonstrate new high-purity OAM states with quantum numbers reaching  $\ell = 100$  and non-symmetric vector vortex beams that lase simultaneously on independent OAM states as much as  $\Delta\ell = 90$  apart, an extreme violation of previous symmetric spin-orbit lasing devices. Our laser conveniently outputs in the visible, producing new OAM states of light as well as all previously reported OAM modes from lasers, offering a compact and power-scalable source that harnesses intracavity structured matter for the creation of arbitrary chiral states of structured light.

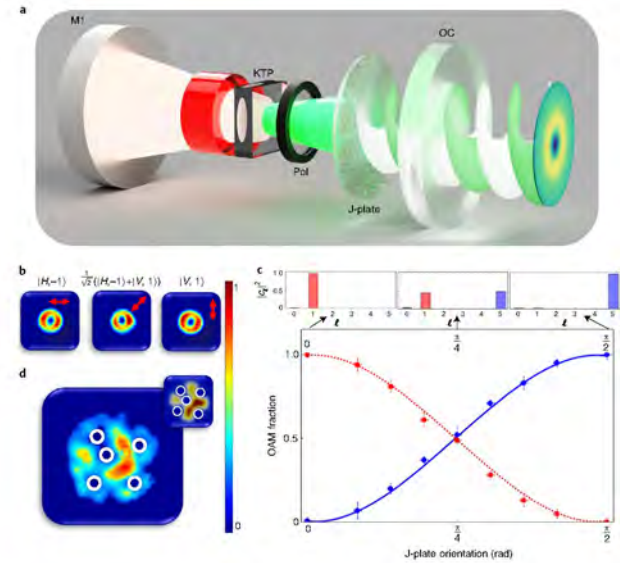
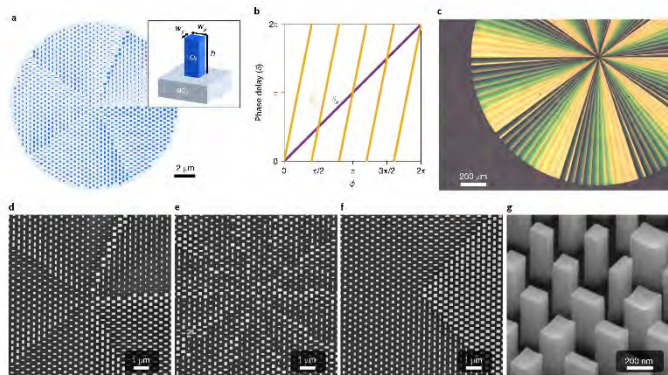

**a**, Illustration of laser cavity with an intracavity nonlinear crystal (KTP), polarizer (Pol) and metasurface (J-plate), excited by an infrared pump (between mirror M1 and the back KTP crystal face), with the green light emerging from the output coupler (OC) mirror. **b**, Replication of previous SO laser results showing symmetric states of for three orientations of the fast axis of JP1 (red arrows). **c**, Creation of a new angular momentum states as  $\theta$  (J-plate orientation) is varied, the modal spectrum shifts from  $||H, 1\rangle$  (red squares) to  $||V, 5\rangle$  (blue circles), in agreement with theory (curves). Insets: the OAM spectrum at different  $\theta$ . Error bars show standard deviations. **d**, Creation of an arbitrary vector superposition state of coherently mixed vortices showing five distinct phase singularities (indicated by white circles), in agreement with theory (shown in the inset). All results were taken at an average pump energy of 230 mJ. For **b** and **d**, the colour bar shows normalized intensity plotted with a false colour scale of 0 to 1.

Hend Sroor, Yao-Wei Huang, Bereneice Sephton, Darryl Naidoo, Adam Vallés, Vincent Ginis, Cheng-Wei Qiu, Antonio Ambrosio, Federico Capasso and Andrew Forbes; Harvard University.

This work was supported by NSF NNCI Award ECCS-1541959. *Nature Photonics*, Vol 14 (8), pg 498.

# Engineering Electron–Phonon Coupling of Quantum Defects to a Semi-confocal Acoustic Resonator

Fuchs, Bhave and coworkers designed and fabricated a semiconfocal HBAR (SCHBAR) device on diamond (silicon carbide) with  $f \times Q > 10^{12}$  ( $>10^{13}$ ). Diamond-based MEMS enable direct coupling between the quantum states of nitrogen-vacancy (NV) centers and the phonon modes of a mechanical resonator. This example, a diamond high-overtone bulk acoustic resonator (HBAR), features an integrated piezoelectric transducer and supports high-quality factor resonance modes into the gigahertz frequency range. The acoustic modes allow mechanical manipulation of deeply embedded NV centers with long spin and orbital coherence times. Unfortunately, the spin-phonon coupling rate is limited by the large resonator size,  $>100 \mu\text{m}$ , and thus strongly coupled NV electron–phonon interactions remain out of reach in current diamond BAR devices. The semiconfocal geometry confines the phonon mode laterally below  $10 \mu\text{m}$ . This drastic reduction in modal volume enhances defect center coupling to a mechanical mode by 1000 times compared to prior HBAR devices. For the native NV centers inside the diamond device, we demonstrate mechanically driven spin transitions and show a high strain-driving efficiency with a Rabi frequency of  $(2\pi)2.19(14) \text{ MHz/Vp}$ , which is comparable to a typical microwave antenna at the same microwave power, making SCHBAR a power-efficient device useful for fast spin control, dressed state coherence protection, and quantum circuit integration.

Fuchs, Bhave et al., Cornell Univ. This work used the Cornell Nanoscale Facility.

This work was supported by ONR (N000141712290) and DARPA DRINQS program (#D18AC00024). *Nano Lett.* 2019, 19, 7021–7027.

*National Research Priority: NSF-Quantum Leap*

# Anomalous Charge Noise in Superconducting Qubits

Plourde, McDermott, and coworkers fabricated experimental qubits. They used Ramsey tomography to characterize charge noise in a weakly charge-sensitive superconducting qubit. The noise exponent and magnitude of the low-frequency noise are much larger than those seen in prior work on single electron transistors, yet are consistent with reports of frequency noise in other superconducting qubits. Moreover, they observe frequent large-amplitude jumps in offset charge exceeding  $0.1e$ ; these large discrete charge jumps are incompatible with a picture of localized dipolelike two-level fluctuators. The data reveal an unexpected dependence of charge noise on device scale and suggest models involving either charge drift or fluctuating patch potentials.

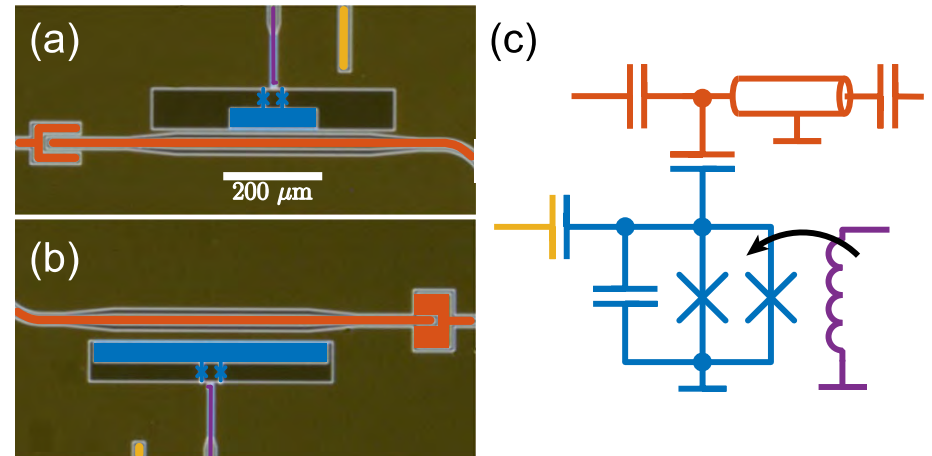

Plourde, McDermott et al., Purdue Univ., Univ. of Wisconsin. This work used the Cornell Nanoscale Facility.

This work was supported by Office of the Director of National Intelligence (ODNI), (IARPA), via the US Army Research Office Grant No. W911NF-16-1-0114. *Phys Rev. B* 100, 140503(R) (2019)

*National Research Priority: NSF-Quantum Leap*

# Mode Structure in Superconducting Metamaterial Transmission-Line Resonators

Plourde, McDermott, and coworkers fabricated experimental qubits. Superconducting metamaterials are a promising resource for quantum-information science. In the context of circuit QED, they provide a means to engineer on-chip dispersion relations and a band structure that could ultimately be utilized for generating complex entangled states of quantum circuitry, for quantum-reservoir engineering, and as an element for quantum-simulation architectures. Here we report on the development and measurement at millikelvin temperatures of a particular type of circuit metamaterial resonator composed of planar superconducting lumped-element reactances in the form of a discrete left-handed transmission line that is compatible with circuit QED architectures. Results are observed to be in good quantitative agreement with numerical simulations and also an analytical model based upon current-voltage relationships for a discrete transmission line. In particular, they demonstrate that the metamaterial mode frequencies, spatial profiles of current and charge densities, and damping due to external loading can be readily modeled and understood, making this system a promising tool for future use in quantum-circuit applications and for studies of complex quantum systems

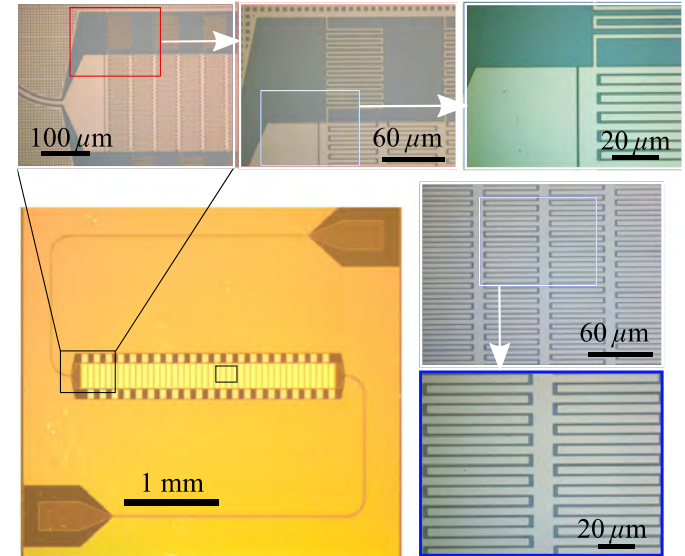

Plourde, McDermott et al., Syracuse Univ. and Univ. of Wisconsin. This work used the Cornell Nanoscale Facility.

This work was supported by ARO Grants No. W911NF-14-1-0080 and No. W911NF-15-1-0248. *Phys Rev Appl* 11, 054062 (2019)

National Research Priority: NSF-Quantum Leap



# A Tunable Topological Charge Vortex Microlaser

In the digital era of proliferating connections between pervasive endpoints, the tremendously growing data traffic motivates the development of innovative optical communication technologies. The current infrastructure based on wavelength and time division multiplexing, together with other degrees of freedom of light including the amplitude, polarization, and phase, is, nevertheless, approaching a bottleneck.

Fortunately, the full-vector nature of light provides another information dimension, namely, the orbital angular momentum (OAM), to ease the upcoming information crunch.

Spin-orbit coupling based on the conservation of the sum of the OAM and transverse spin was exploited to precisely maneuver the chiral light states in micro-ring lasers.

This tunable vortex microlaser is capable of emitting vortex beams of 5 different topological charges at room temperature. The toolbox of generating various vortex light at a single wavelength holds the promise for future development of multi-dimensional OAM-spin-wavelength division multiplexing for high-density data transmission in classical and quantum regimes.

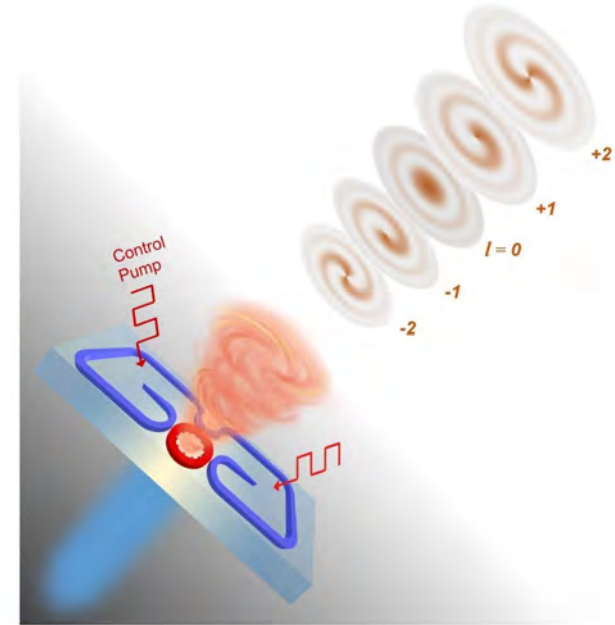

*Schematic of non-Hermitian controlled vortex microlaser.*

Liang Feng, Departments of Materials Science and Engineering and Electrical and Systems Engineering, U. Penn.  
Ritesh Agarwal, Materials Science and Engineering, U. Penn, Natalia M. Litchinitser, and Jingbo Sun, Duke University,  
Josep M. Jornet, Northeastern University, and Stefano Longhi, Politecnico di Milano.

*National Research Priority: NSF-Quantum Leap and NSF-Harnessing the Data Revolution*

# Influence of surface etching and oxidation on the morphological growth of $\text{Al}_2\text{O}_3$ by ALD

Selective deposition using ALD may be a viable way to grow patterned nanostructured materials. This study found that etching HOPG produces different densities of functional groups and different morphologies that influenced the growth of ALD  $\text{Al}_2\text{O}_3$  structures, depending on the etchant. Hydrochloric acid produced a high density of  $-\text{OH}$  and  $-\text{COOH}$  functional sites on terrace regions. Different structures grew on the functional sites compared to defect sites. Nucleation and growth are affected by the surface functionalization as well as the topography and density of functional sites. These results suggest that understanding both the topography and type of functional site are necessary for designing the next-generation electronic devices and catalysts.

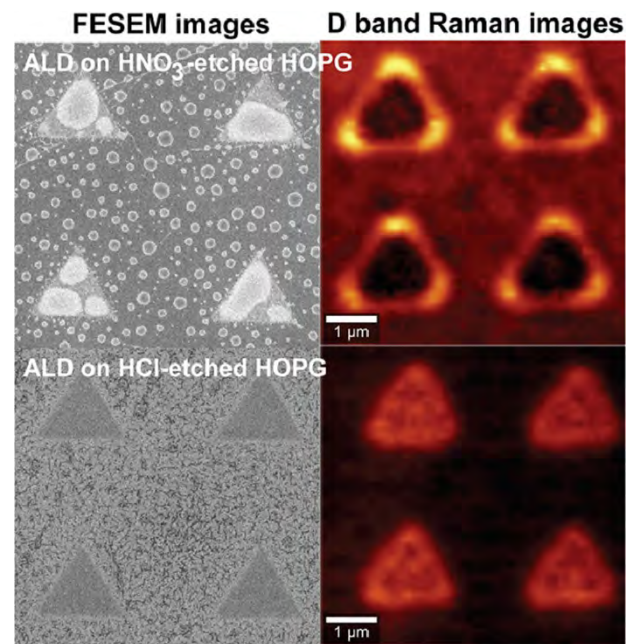

FESEM micrographs (left) and Raman maps (right) of Atomic Layer Deposition (ALD) growth of  $\text{Al}_2\text{O}_3$  on  $\text{HNO}_3$  etched (top) and HCl etched (bottom) HOPG.

Mikhail Trought, Isobel Wentworth, Chathurade Alwis, Timothy R. Leftwich, Kathryn A. Perrine, Michigan Technological University. Work performed at Minnesota's Nano Center.

*Surface Science*, 690, 121479, 2019.

National Research Priority: NSF-Quantum Leap

# Toward High-Performing Topological Edge-State Optical Isolators

This work demonstrates topological edge-state arrays with power confinement in the edge state as high as 29 dB relative to its farthest channel. Average insertion losses of <2 dB in the edge channel vs total output power in the whole array are measured. The device follows a Su-Shrieffer-Heeger construction, consisting of seven waveguides fabricated on (100) liquid-phase-epitaxy-grown bismuth-substituted lutetium iron garnet films on a gadolinium gallium garnet substrate. The delocalization of the field can be realized by magnetizing only the single edge-state channel, thereby diverting the backscattered signal to serve as a high-performing optical isolator with a predicted isolation ratio as high as -50 dB. Methods and challenges for full experimental implementation of a SSH topology-based optical isolator are discussed.

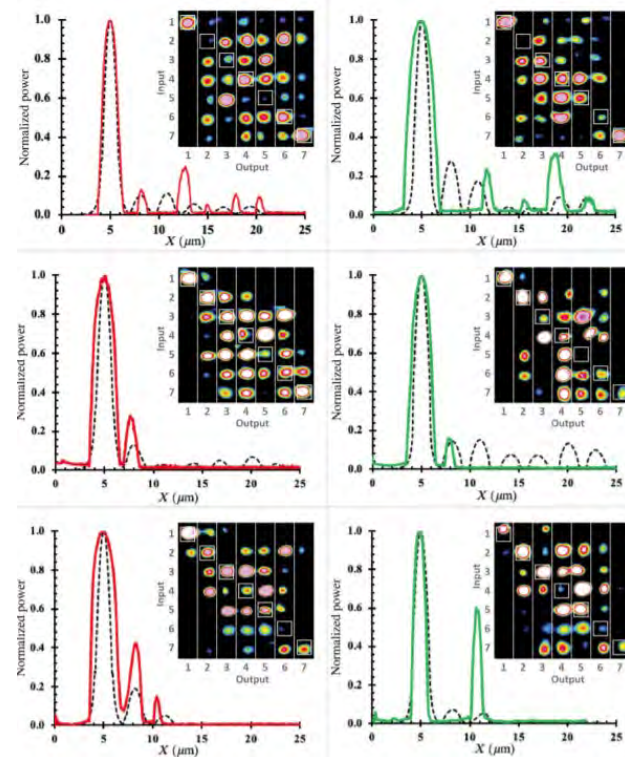

Light intensity (insert), TE and TM results (red and green lines) and simulation (dashed lines) for various geometries..

Dolendra Karki, Ramy El-Ganainy, Miguel Levy, Michigan Technological University. Work performed at Minnesota's Nano Center.

*Physical Review Applied*, 11, 034045, 2019.

National Research Priority: NSF-Quantum Leap



# Deposition of Surface Passivated Black Phosphorus Thin Films

A single-step, direct silicon-substrate growth method for large thin film single crystals of black phosphorus (BP) crystals is achieved. Furthermore, *in situ* Sn passivation of BP occurs, allowing long-term stability. The growth results are independent of the substrate. Cross-sectional TEM shows that elemental Sn encapsulates BP crystals and crystalline  $\text{SnI}_x$  inclusions are scattered throughout the BP crystal. High resolution TEM suggests that these inclusions may provide the dominant mechanism for seeding vertical growth. IR absorption measurements for thin and bulk BP recipes show an equal response below  $E_g$  dominated by free carrier absorption. FET devices fabricated from thin-film and bulk BP recipes show improved device performance compared to unpassivated BP films of equal thickness with an on/off current ratio  $>10^2$ .

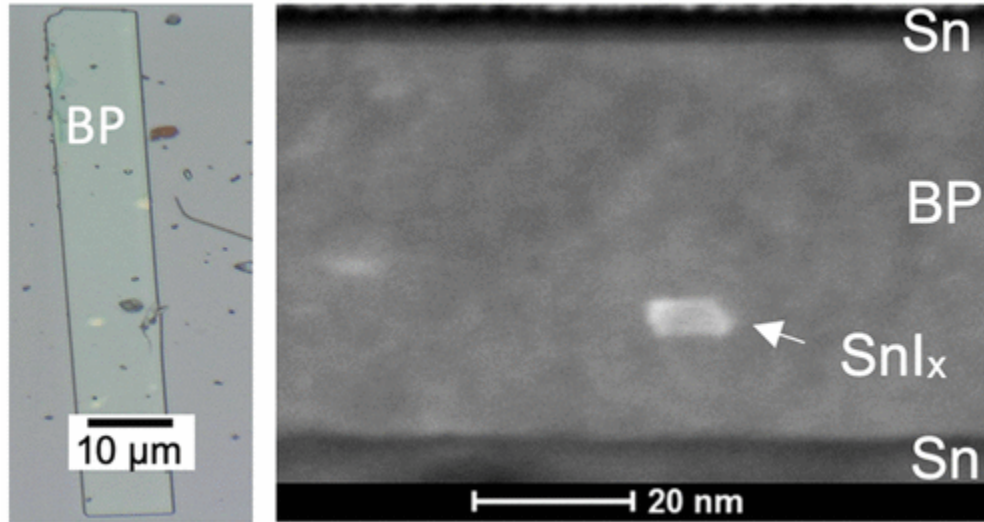

A 115 nm-thick BP mono single BP crystal with lateral dimensions of  $10 \times 85 \mu\text{m}$  (left) and a cross section TEM image of the structure showing Sn encapsulation and an embedded  $\text{SnI}_x$  crystal.

Nezhueyotl Izquierdo, Jason Myers, Nicholas C.A. Seaton, Sushil K. Pandey, Stephen A. Campbell. Work performed at Minnesota's Nano Center.

ACS Nano, 13(6), 7091-7099, 2019.

National Research Priority: NSF-Quantum Leap

# MoTe<sub>2</sub> Lateral Homojunction Field-Effect Transistors Fabricated Using Flux-Controlled Phase Engineering

Transition-metal dichalcogenide (TMDCs) FETs suffer from large contact resistances. Semiconducting hexagonal (2H) molybdenum ditelluride (MoTe<sub>2</sub>) phase, metallic monoclinic (1T') MoTe<sub>2</sub> phase, and their lateral homojunctions may provide a solution. We investigated *in situ*-grown lateral 2H/1T' MoTe<sub>2</sub> homojunctions grown using flux-controlled phase engineering. We show that the round regions of near-single-crystalline 2H-MoTe<sub>2</sub> grow out of a polycrystalline 1T'-MoTe<sub>2</sub> matrix. We further demonstrate the operation of MoTe<sub>2</sub> FETs made on these *in situ*-grown lateral homojunctions with 1T' contacts. The structure substantially decreases the contact resistance. Transport measurements reveal a flat-band barrier height that is several times smaller and shows a stronger gate modulation, compared to the metal/2H Schottky barrier height.

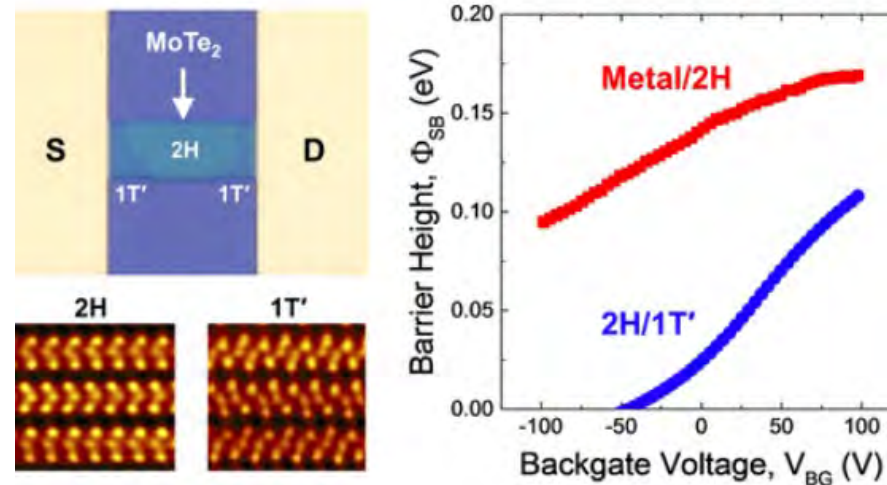

Structure and high resolution TEM images of the lateral heterojunction device (left) and barrier height of conventional (red) and heterojunction (blue) contacts.

Rui Ma, Huairuo Zhang, Youngdong Yoo, Zachary Patrick Degregorio, Lun Jin, Prafful Golani, Javad Ghasemi Azadani, Tony Low, James E. Johns, Leonid A. Bendersky, Albert V. Davydov, and Steven J. Koester. Work performed at Minnesota's Nano Center.

ACS Nano 13, 8035-8046, 2019.

National Research Priority: NSF-Quantum Leap

# Polar coupling enabled nonlinear optical filtering at MoS<sub>2</sub>/ferroelectric heterointerfaces

Dawei and coworkers at UNL used NNF facilities and report an unconventional nonlinear optical filtering effect resulting from the interfacial polar alignment between monolayer MoS<sub>2</sub> and a neighboring ferroelectric oxide thin film. The second harmonic generation response at the heterointerface is either substantially enhanced or almost entirely quenched by an underlying ferroelectric domain wall depending on its chirality, and can be further tailored by the polar domains. Unlike the extensively studied coupling mechanisms driven by charge, spin, and lattice, the interfacial tailoring effect is solely mediated by the polar symmetry, as well explained via their density functional theory calculations, pointing to a new material strategy for the functional design of nanoscale reconfigurable optical applications.

Dawei Li, Xi Huang, Zhiyong Xiao, Hanying Chen, Le Zhang, Yifei Hao, Jingfeng Song, Ding-Fu Shao, Evgeny Y Tsymbal, Yongfeng Lu, and Xia Hong. Work performed in part at the Nebraska Nanoscale Facility.

This work was supported by DOE DE-SC0016153, NSF Nebraska MRSEC DMR-1420645, NSF CMMI 1826392 and ONR N00014-15-C-0087. *Nature Communications* 11, 1422, 2020.

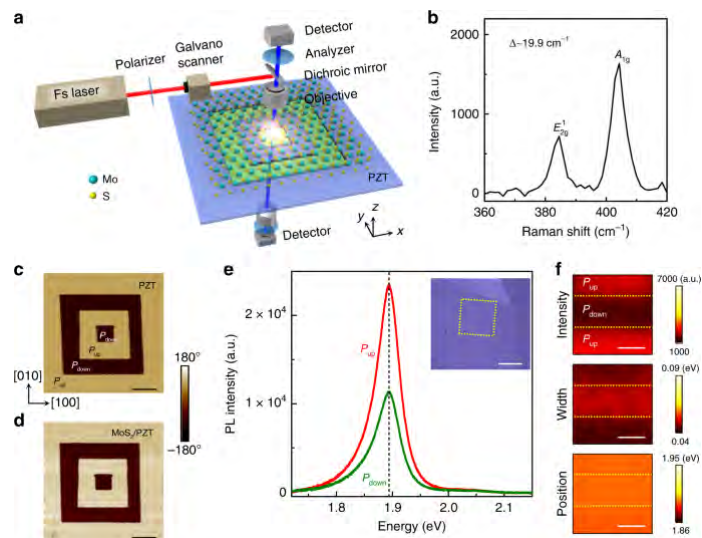

*a* Schematic of the SHG experimental set-up. *b* Raman spectrum of a 1L MoS<sub>2</sub> flake on gel film showing E<sub>2g</sub><sup>1</sup> mode at 384.0 cm<sup>-1</sup> and A<sub>1g</sub> mode at 403.9 cm<sup>-1</sup>. *c, d* PFM phase images, Crystalline orientation of PZT. The scale bars are 3 μm. *e* Room temperature PL spectra of the 1L MoS<sub>2</sub> on the P<sub>up</sub> and P<sub>down</sub> domains shown in *d*. The scale bar is 10 μm. *f* PL mapping of the peak intensity (upper), width (middle), and position (lower) on a 1L MoS<sub>2</sub>/PZT sample. The dotted lines mark the DW positions. The scale bars are 2 μm.

National Research Priority: NSF-Quantum Leap



# Low-Voltage Domain-Wall LiNbO<sub>3</sub> Memristors

Application of conducting ferroelectric domain walls (DWs) as functional elements may facilitate development of conceptually new resistive switching devices. Here, Chaudhary and co-workers at UNL used NNF facilities and demonstrated a new approach based on tuning the conductivity of DWs themselves rather than on domain rearrangement. Using LiNbO<sub>3</sub> capacitors with graphene, the authors showed that resistance of a device set to a polydomain state can be continuously tuned by application of subcoercive voltage. The tuning mechanism is based on the reversible transition between the conducting and insulating states of DWs. The developed approach allows an energy-efficient control of resistance without the need for domain structure modification. A big step forward here is that the authors have found a solid-state electrode, graphene, which does not get burned by the strong currents induced during the DW writing process in contrast to the delaminating metal electrodes. This finding along with the low-voltage operation paves the way for development of realistic functional memristive devices. The developed memristive devices are promising for multilevel memories and neuromorphic computing applications.

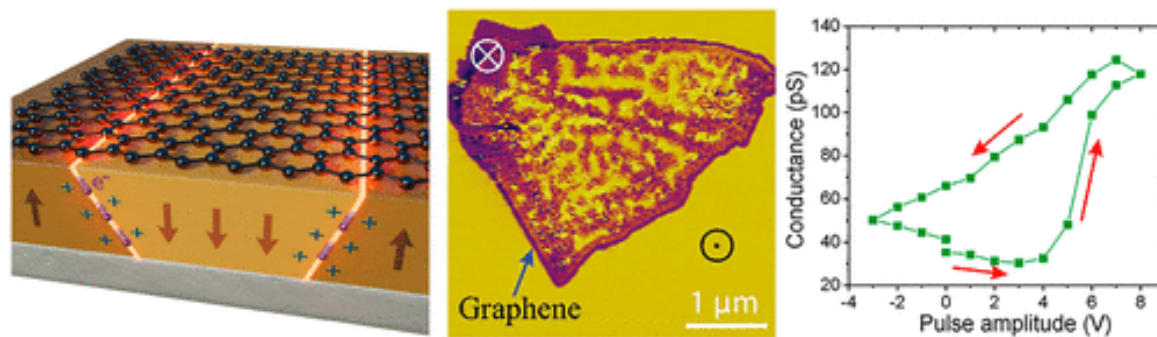

P. Chaudhary, H. Lu, A. Lipatov, Z. Ahmadi, J. P. V. McConville, A. Sokolov, J. E. Shield, A. Sinitskii, J. M. Gregg, and A. Gruverman. Univ. of Nebraska–Lincoln and Queen’s University Belfast. Work performed in part at the Nebraska Nanoscale Facility.

This research was supported by the NSF DMR-1709237, Nebraska MRSEC DMR-1420645, PSRC (No. EP/P02453X/1) and US-Ireland R&D Partnership Programme (USI 120). *ENano Letters*, 2020, 20, 8, 5873–5878.

*National Research Priority: NSF-Quantum Leap*



# Voltage controlled magnetism in $\text{Cr}_2\text{O}_3$ based all-thin-film systems

Wang and coworkers at UNL used NNF facilities and demonstrated voltage-control of exchange biases through active selection of distinct domain states of the magnetoelectric and antiferromagnetic pinning layer is for  $\text{Cr}_2\text{O}_3/\text{CoPd}$  heterostructures. In this work, progress and obstacles towards an isothermal switching of exchange bias are discussed. An alternative approach avoiding exchange bias for voltage-controlled memory exploits boundary magnetization at the surface of  $\text{Cr}_2\text{O}_3$  as voltage-controlled state variable. The authors demonstrate readout and switching of boundary magnetization in ultra-thin  $\text{Cr}_2\text{O}_3/\text{Pt}$  Hall bar devices where reversal of boundary magnetization is achieved via magnetoelectric annealing with simultaneously applied  $\pm 0.5$  V and 400 mT electric and magnetic fields. This result shows evidence for scalability of energy efficient magnetoelectric devices for memory and logic.

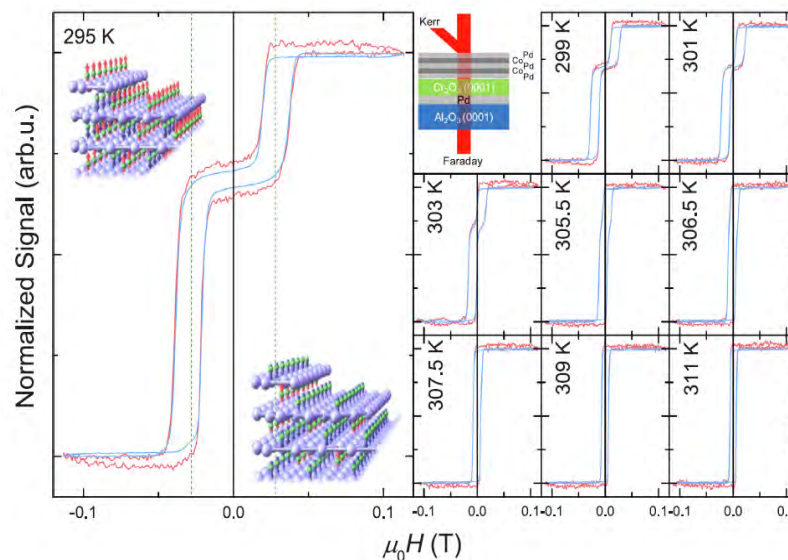

Exchange bias hysteresis loops of a Co/Pd multilayer on top of a multi-domain  $\text{Cr}_2\text{O}_3$  (0001) layer of 250 nm. Left panel shows the coexistence of exchange biases with opposite signs over the corresponding domains of  $\text{Cr}_2\text{O}_3$ . Right panels show the evolution of the exchange biases as temperature changes from

Jun-Lei Wang, Will Echtenkamp, Ather Mahmood, Christian Binek, Univ of Nebraska-Lincoln. Work performed in part at the Nebraska Nanoscale Facility.

This work was supported by in part by AMML, one of centers in nCORE as task 2760.001, an SRC program sponsored by the NSF ECCS 1740136 and the Nebraska MRSEC DMR-1420645. *Journal of Magnetism and Magnetic Materials* 486, 165262, 2019

National Research Priority: NSF-Quantum Leap

# Resistive Swit. in Individual Co/ZnO Core/Shell Nanoparticles Formed via Inert Gas Condensation and Selective Oxidation

Ahmadi and coworkers at UNL utilized NNF facilities and used magnetron sputtering inert gas condensation to produce core/shell Co/ZnO nanoparticles. In this work, bipolar resistive switching is reported for the first time in individual core/shell nanoparticles with sizes on the order of 50 nm. Selective oxidation to form the core/shell nanoparticles is accomplished both during nanoparticle formation (“in situ”) and with exposure to ambient conditions (“ex situ”). Conductive atomic force microscopy is utilized to measure the electrical behavior of individual nanoparticles, and both types of core/shell nanoparticles display classic bipolar resistive switching behavior. These results highlight potential application of these nanoparticles as promising next generation nonvolatile memories and neuromorphic computational devices.

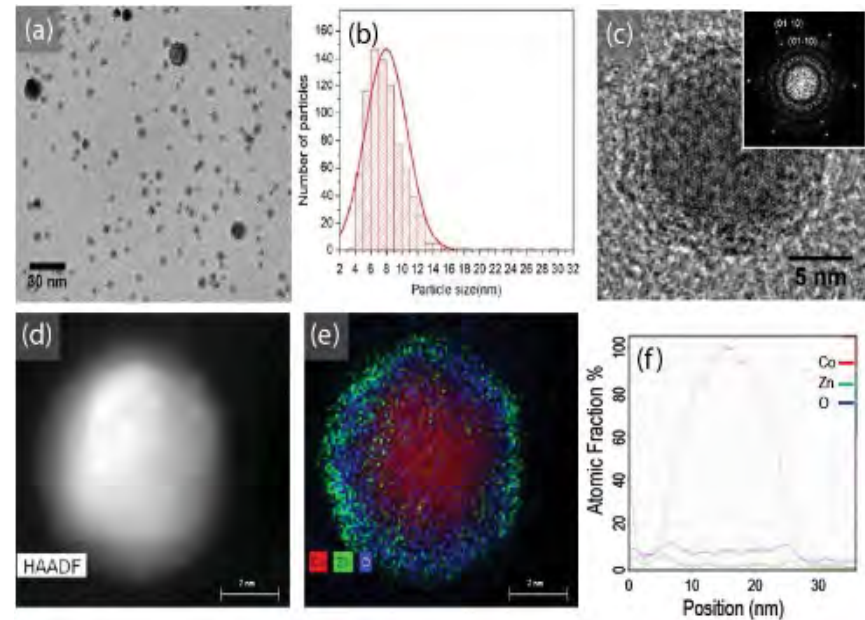

In situ-formed Co/ZnO nanoparticles. a) Low magnification TEM images and b) size distribution fitted with a Gaussian curve. c) HRTEM image; inset shows the FFT. d) HAADF-STEM image; e) EDS elemental map, and f) line scan showing the composition across the nanoparticle diameter.

Zahra Ahmadi, Haidong Lu, Mark Koten, Alexi Gruverman, Jeffrey Shield, Univ. of Nebraska-Lincoln. Work performed in part at the Nebraska Nanoscale Facility.

This work was supported by NSF through the MRSEC (DMR-1420645). *Advanced Electronic Materials* 6, 2000065, 2020.

*National Research Priority: NSF-Quantum Leap and NSF-Growing Convergence Research*

# Computation: SPINS/Spins-B software package

In years 1-5 nano@stanford researchers contributed to the development of 14 software packages, including piezoD (Prof. Pruitt), GFET Tool (Prof. Pop), and SU RRAM Model (Prof. Wong).

The most recently published software is the SPINS package (Stanford Photonic INverse design Software) aimed at nanophotonic design optimization, developed by Prof. Jelena Vuckovic and her research team (2019).

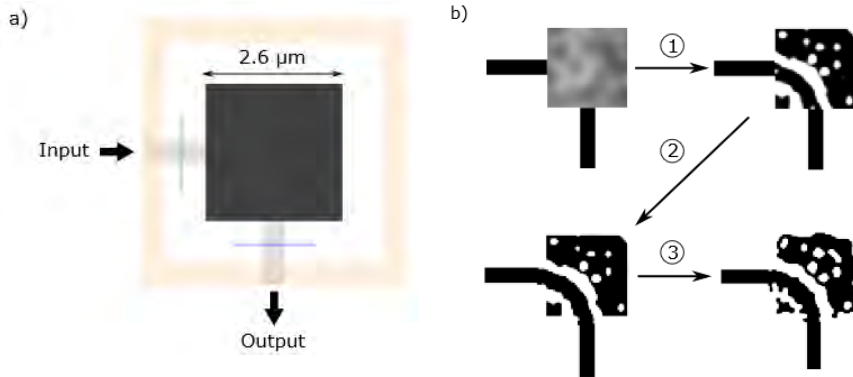

a) Problem setup b) Optimization sequence.

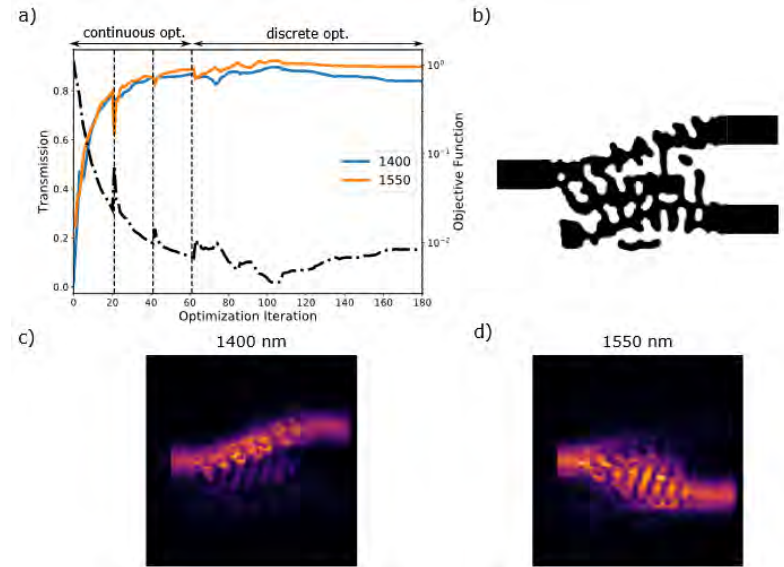

Device A2. a) Transmission (solid) and objective value (dotted) as a function of optimization iteration. The vertical dotted lines indicate the start of a new transformation. Discretization occurs in between the continuous and discrete optimization stages. b) Final device design. c) Electric field intensity at 1400 nm. d) Electric field intensity at 1550 nm.

Jelena Vuckovic, Department of Electrical Engineering, Stanford University. Work performed at Stanford Nano Shared Facilities, nano@stanford site.

This work was supported by NSF Award # ECCS-1542152. <https://arxiv.org/pdf/1910.04829>

National Research Priority: NSF-Quantum Leap



# Electrically Reconfigurable Waveguide-Integrated Phase-Change Material Photonic Memristive Switch

We demonstrated an electrically reconfigurable non-volatile optical switch made of GeSbTe (GST) on silicon photonic platform. By changing the material phase of GST between amorphous and crystalline states, we observed a large modulation of the optical transmission, in both silicon waveguide and ring resonator. Being able to do this using an external electrical signal, we are in a position to scale the system. Such a scalable photonic system will find applications in optical field programmable gate arrays, and creating large scale quantum optical systems, where the active devices are connected via a reconfigurable network to increase the system yield.

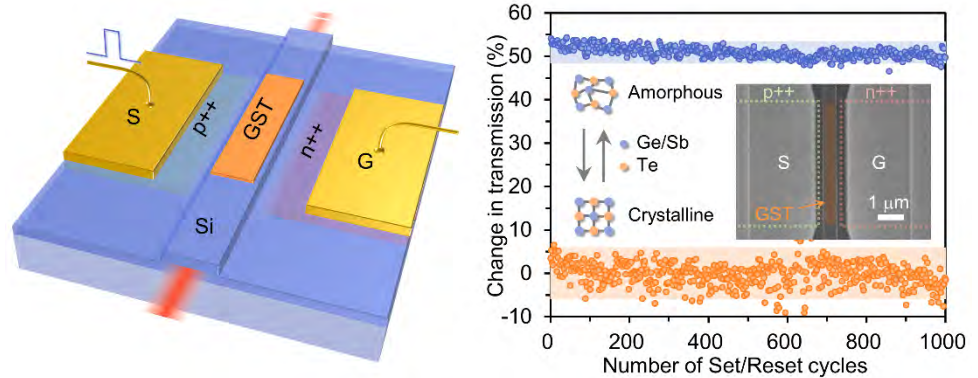

Fig. (a) Schematic of the photonic memristive switching unit. (b) Cyclability of the photonic switch at 1550 nm. Inset: schematic of the GST structure changes due to the phase transitions and SEM image of the active region.

Jiajiu Zheng, Zhuoran Fang, Arka Majumdar, University of Washington. This work was performed at the NNI site.

This work was supported by NSF Award # 2040527, NNCI-1542101 and NESACBIO NIH P41 (EB002027). Publication: 10.1002/adma.202001218.

National Research Priority: NSF-Quantum Leap and NSF-Growing Convergence Research

# Metasurface Integrated Monolayer Exciton Polariton

Monolayer transition-metal dichalcogenides (TMDs) are the first truly two-dimensional (2D) semiconductor, providing an excellent platform to investigate light–matter interaction in the 2D limit. The inherently strong excitonic response in monolayer TMDs can be further enhanced by exploiting the temporal confinement of light in nanophotonic structures. Here, we demonstrate a 2D exciton–polariton system by strongly coupling atomically thin tungsten diselenide ( $\text{WSe}_2$ ) monolayer to a silicon nitride (SiN) metasurface. Via energy-momentum spectroscopy of the  $\text{WSe}_2$ -metasurface system, we observed the characteristic anti-crossing of the polariton dispersion both in the reflection and photoluminescence spectrum.

Publication: *acs.nanolett.0c01624*

Yueyang Chen, Arka Majumdar, University of Washington. This work was performed at the NNI site.

This work was supported by NSF Award # NNCI-1542101 and NESACBIO NIH P41 (EB002027).

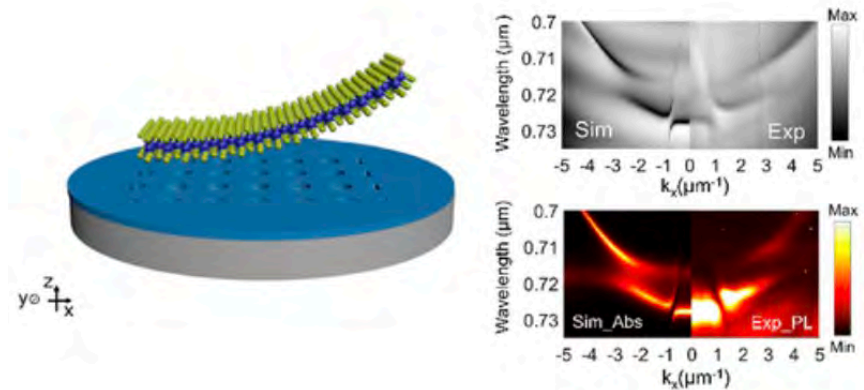
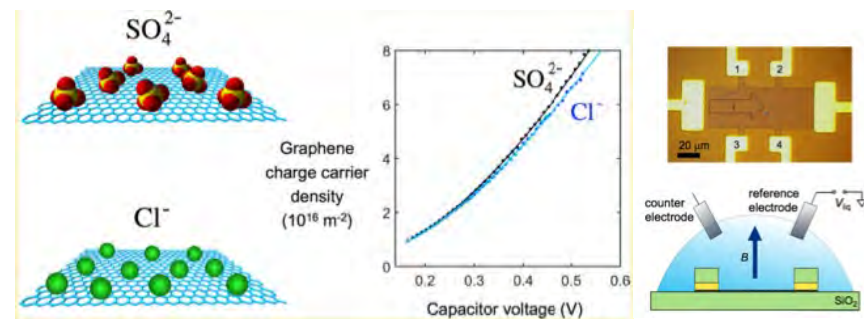

Fig. Monolayer TMD integrated with a SiN metasurface platform is used to demonstrate exciton-polaritons.

National Research Priority: NSF-Quantum Leap

# Hall Effect Measurements of the Double-Layer Capacitance of the Graphene-Electrolyte Interface

There is an ongoing effort to improve the energy storage capacity of graphene-based supercapacitors. These supercapacitors store energy in the electric field between the charge carriers in the graphene and the counter ions in a liquid electrolyte. To characterize this double layer, we use the Hall effect to determine the charge carrier density in graphene as a function of voltage. We disentangle the separate roles of double-layer capacitance (the electrostatic contribution) and quantum capacitance and compare the performance of different electrolytes. Our results highlight the advantages of Hall effect measurements for probing the electrostatics of graphene–electrolyte interfaces.



Top: Left: Anions absorbed on graphene sheet. Middle: Sheet density of holes in the graphene measured as a function of voltage in  $\text{NaCl}$  and  $\text{Na}_2\text{SO}_4$ . Right: Optical image of the graphene devices and cross-sectional schematic of the device design

Morgan A. Brown, Michael S. Crosser, Agatha C. Ulibarri, Carly V. Fengel, Ethan. S. Minot, Dept. of Physics, Oregon State University, and Dept. of Physics, Linfield College. Work performed at MASC of NNI site.

*J. Phys. Chem. C* (2019), doi: [10.1021/acs.jpcc.9b03935](https://doi.org/10.1021/acs.jpcc.9b03935)

National Research Priority: NSF-Quantum Leap

# Ratcheting Quasi-ballistic Electrons

Ratcheting effects play an important role in systems ranging from mechanical socket wrenches to biological motor proteins

Designed a semiconductor nanowire with precisely engineered asymmetry capable of ratcheting electrons at room temperature

Modulation of the nanowire diameter creates a cylindrical sawtooth geometry on a nanometer-length scale

Ratcheting effect causes charge rectification at frequencies exceeding 40 gigahertz, demonstrating the potential for applications such as high-speed data processing and long-wavelength energy harvesting

James Custer and Jim Cahoon, Dept. of Chemistry, University of North Carolina at Chapel Hill. Work performed at the Chapel Hill Analytical and Nanofabrication Laboratory.

Work supported by the Packard Foundation. *Science*, 368 (2020).

*National Research Priority: NSF-Quantum Leap*



SEM image of a nanowire with three geometric diodes in series (Scale bar = 200 nm)

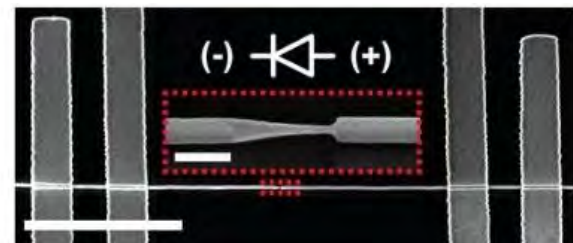

SEM image of a single nanowire device with electrical contacts (Scale bar = 5  $\mu\text{m}$ ), Inset shows geometric diode and circuit diagram (Scale bar = 250 nm)

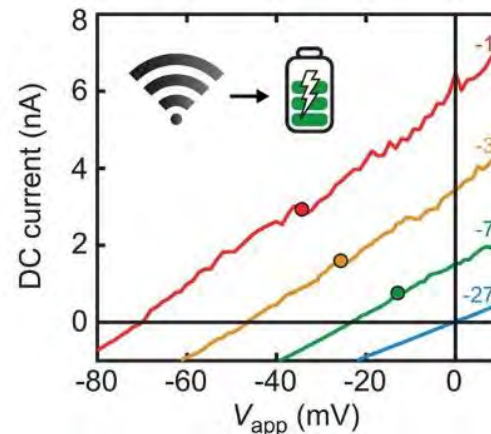

*I-V response of a geometric diode with 5.2-GHz ac applied at varying powers*



# Nitrogen-Vacancy (NV) Nanodiamond Quantum Device

## Scientific and engineering significance:

Nitrogen-vacancy (NV) center is a transformative tool in exploring the magnetic and electric features of material systems with *unprecedented field sensitivity and nanoscale spatial resolution*. Room-temperature quantum entanglement between NV centers can be established by the dipolar fields generated by individual NV spins with a distance less than 50 nm. The entangled NV spin states and the coupling strength can be measured by monitoring the oscillation of the photocurrent as a function of the coupling duration time. This research marks significant advances in quantum materials and quantum systems.

SDNI's unique tools and nanofabrication capabilities have played pivotal roles in enabling this important research.

Nitrogen vacancy (NV) defect in diamond

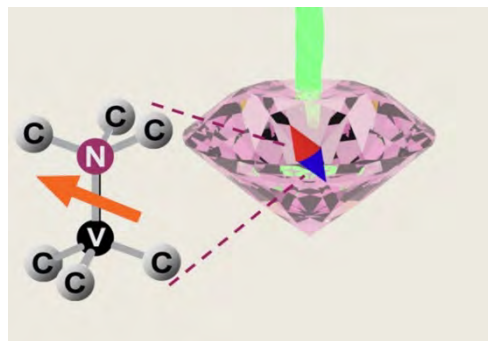

NV quantum device to form entangled states.

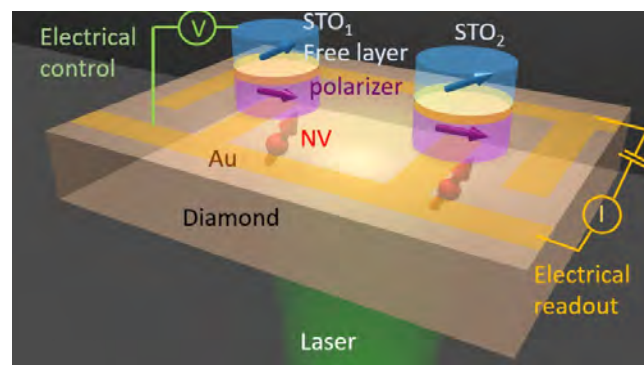

Chunhui Du, Physics Department, UCSD. Work performed at SDNI.

National Research Priority: NSF-Quantum Leap

# Direct thermal neutron detection by the 2D semiconductor ${}^6\text{LiInP}_2\text{Se}_6$

Thermal analysis methods at **SPID** to determine the melting and crystallization temperature of  $\text{LiInP}_2\text{Se}_6$ , a promising material for the detection of thermal neutrons. This work also used the **EPIC** facility in **NUANCE**

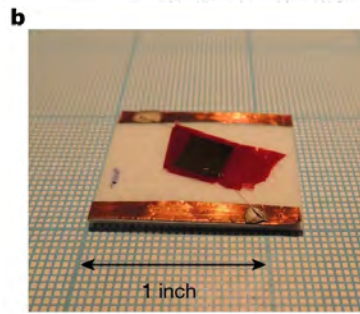
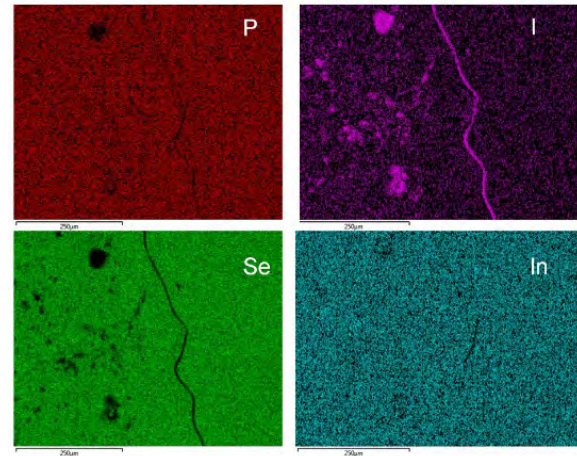
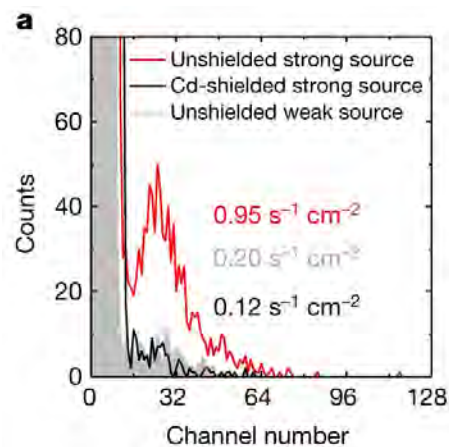

Binned pulse-height spectrum of a  ${}^6\text{LiInP}_2\text{Se}_6$  device (shown in **b**) exposed to a moderated Pu–Be source without shielding (red) and with Cd shielding (0.125 inch thick; black) and to a source ~5 times weaker (grey) for 300 V bias, 3  $\mu\text{s}$  shaping time and 30-min measurements. The composition obtained from EDS from both orientations yielded the semiquantitative formula  $\text{In}_{1.1}\text{P}_{2.0}\text{Se}_{6.0}$ , which is consistent with the expected ratio of 1:2:6 determined from the crystal structure.

Chica and He<sup>†</sup>, Wessels<sup>†</sup>, Kanatzidis<sup>†</sup>, Chung<sup>‡</sup>, Pac<sup>‡</sup>, De Lurgio<sup>‡</sup> et al., <sup>†</sup>Chemistry and MSE at Northwestern University, <sup>‡</sup>MSE and/or Strategic Security Division at Argonne National Lab. This work utilized the NUANCE Center at SHyNE.

This work was supported by NSF ECCS-1542205, NSF DMR-1708254, Argonne National Lab DEO DE-AC02-06CH11357, MRSEC (NSF DMR-1720139). *Nature* 2020, 577, 346–349.

National Research Priority: NSF-Quantum Leap

# Graphene-based High Performance Speakers and Microphones

Reliable multilayer graphene growth on Ni foil was achieved using chemical vapor deposition from methane and other hydrocarbons over entire region at 125 C.

Graphene-enhanced audio transducers were made with better frequency response than conventional transducers.. Graphene transfer process enables large-area graphene suspensions (8 – 20 mm diameter). An optimized process flow was developed to achieve smooth graphene surface morphology and high thermal stability.

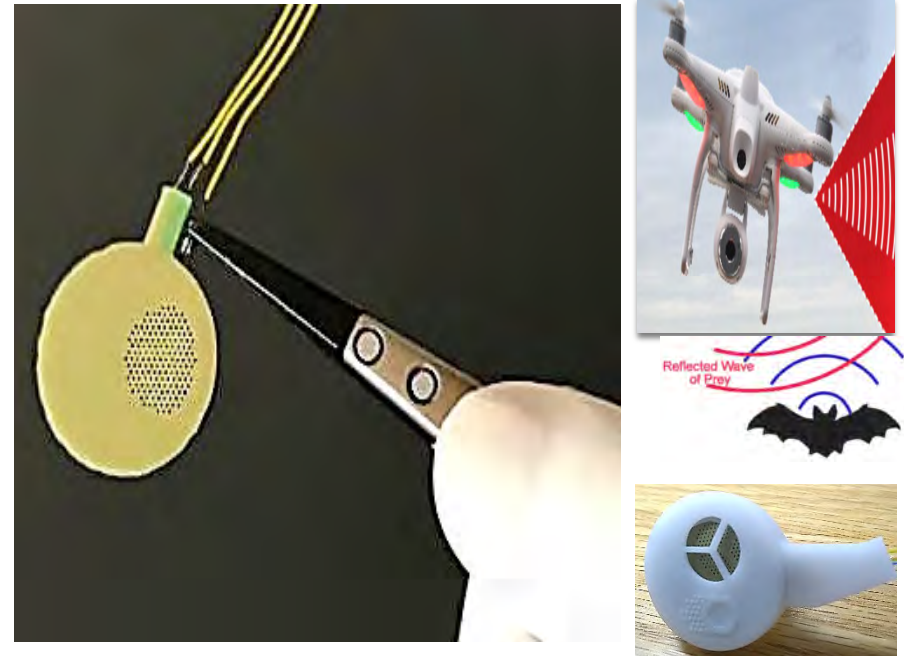

*Graphene film based speaker transducer and applications.*

Burt Fowler, Harry Chou, Lorance Wilson, Graph Audio. Work performed at University of Texas Microelectronics Research Center.

This work was supported by venture capital funds

*National Research Priority: NSF-Quantum Leap*



# Band Structure Engineering of Layered $WSe_2$ via 1-Step Chemical Functionalization

This work targeted band structure engineering of tungsten diselenide, and p-type doping. The research involved spectroscopic and electrical characterization of a few-layer  $WSe_2$  FET. Optical image and schematic diagram of the back-gated FL  $WSe_2$  FET with Ni/Au top contact electrodes is shown. Room-temperature back-gated transfer characteristics of the FL  $WSe_2$  FET are shown before (black curve) and after (red curve)  $(NH_4)_2S(aq)$  treatment. A clear enhancement of  $I_{ON}$  in the p-branch is observed after  $(NH_4)_2S(aq)$  treatment.

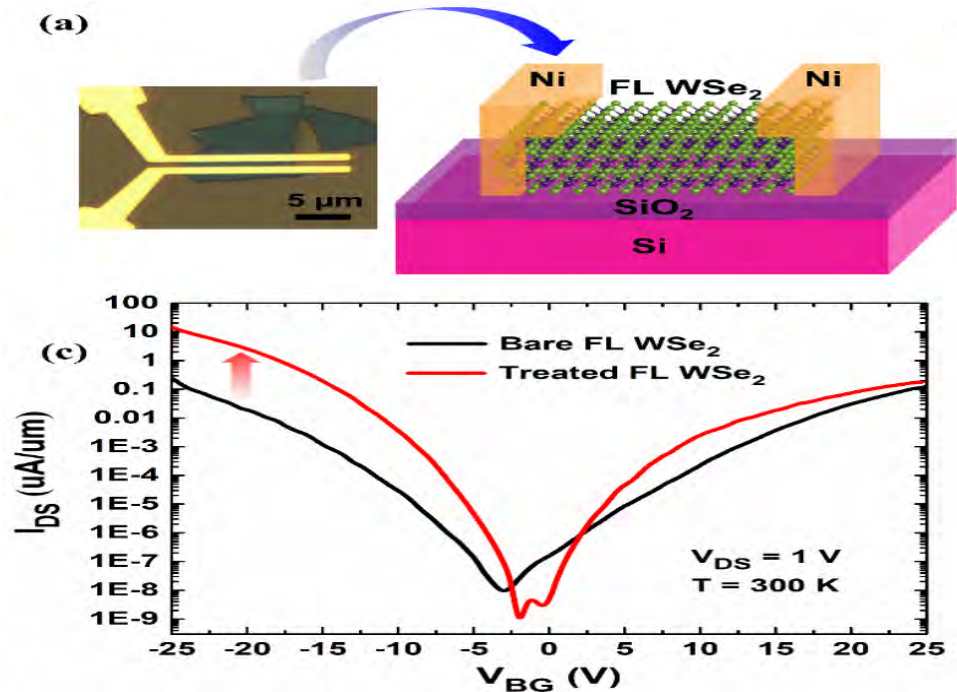

Band structure engineering of layered  $WSe_2$  via one-step chemical functionalization to demonstrate pFETS..

J. Park, A. Rai, ...G. Xing, K. Cho, S. K. Banerjee and A. C. Kummel · Work performed at SDNI, CNF and TNF (Univ. of Texas Microelectronics Research Center).

This was supported by NSF DMR 1207213, DMR1400432, EFRI-2DARE 1433490, EEC-1160494. *ACS Nano* (2019).

National Research Priority: NSF-Quantum Leap

# Moiré Excitons in Van der Waals Heterostructures

Moiré superlattice modulates the electronic and optical properties of a  $\text{MoSe}_2/\text{WSe}_2$  heterobilayer (hBL). Optical image of an hBN-encapsulated  $\text{MoSe}_2/\text{WSe}_2$  stacked heterostructure shows the hBL region inside the black dotted line. Comparison of the photoluminescence spectrum from an uncapped heterostructure and an hBN-encapsulated heterostructure reveals neutral ( $X^0$ ) and charged ( $X^-$ ) exciton emission from the  $\text{MoSe}_2$  and  $\text{WSe}_2$  monolayers. The interlayer exciton ( $IX$ ) emission is observed  $\sim 300$  meV below the intralayer resonances. The Moiré potential landscape and degree of circular polarization were studied.

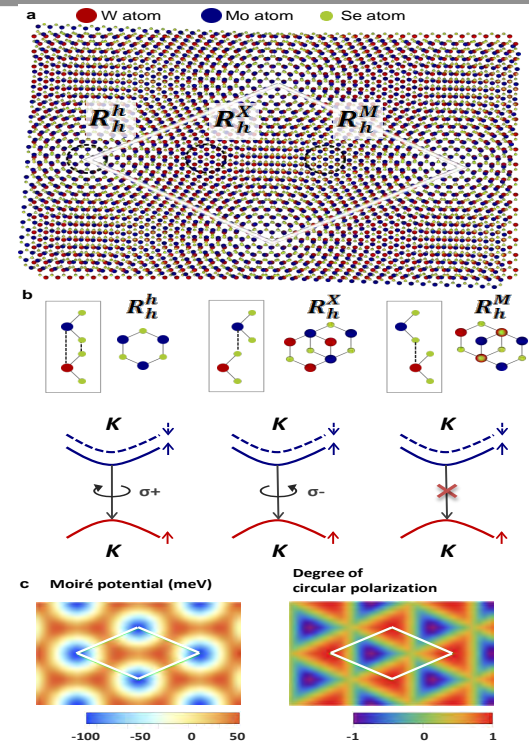

Moiré superlattice modulates the electronic and optical properties of a  $\text{MoSe}_2/\text{WSe}_2$  heterobilayer (hBL) with  $1^\circ$  twist angle.

K. Tran, ... S.K. Banerjee... and X. Li. Work done at NIST, Argonne, Korea and Univ. of Texas Microelectronics Center.

This work was supported by NSF DMR-1720595, EFMA-1542747, EEC-1160494. *Nature*, 567 (7746), 2019.

National Research Priority: NSF-Quantum Leap

# Chemiresistive Sensor Array and Performance

Bioassays employed to evaluate the diverse range of biomarkers associated with organ injury are time-consuming, costly and require multiple instruments/testing formats to reach a diagnosis (i.e. fluorescence-based capture, ELISAs, PCR, etc.). Individually, these platforms are incapable of predicting the onset of irreversible organ tissue injury (e.g. kidney, liver, heart and lung).

One barrier to transitioning microarray technology into multiplex medicinal diagnostics has been the limitations imposed by fluorescence/optical-based labeling and endpoint detection. To overcome these limitations, Nanohmics Inc., developed the SnO<sub>2</sub> nanowire chemiresistive sensor array. The diverse surface derivitizations across array elements allows for incident gas/ion species identification.

The platforms are room temperature operable and provide fast response in gas applications

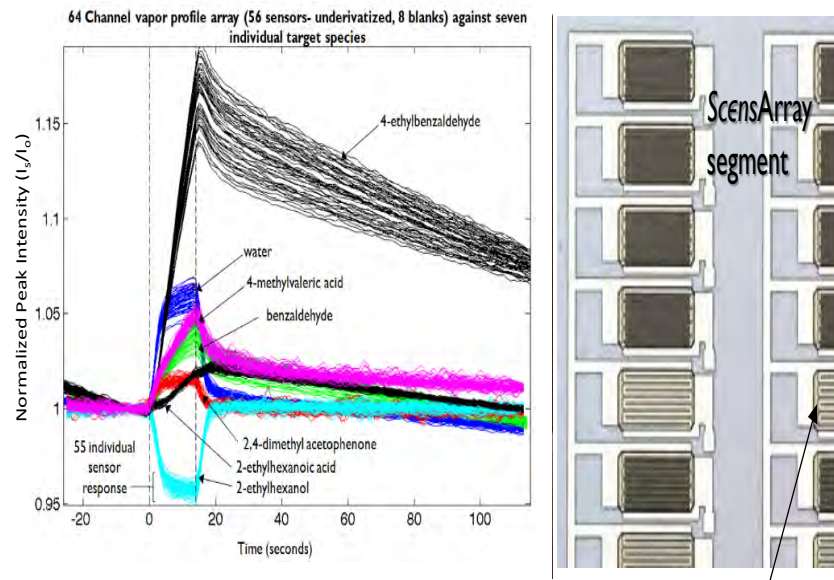

*Bioassays employed to evaluate the diverse range of biomarkers associated with organ injury.*

Steve Savoy, Nanohmics. Work done at Univ. of Texas Microelectronics Center.

This work was supported by DHP Phase II SBIR Program and NIH Phase I SBIR Program.

*National Research Priority: NSF-Quantum Leap*

# Ionic Gating of Van der Waals Heterstructures

Electrostatic gating of two-dimensional (2D) materials with ionic liquids (ILs), leading to the accumulation of high surface charge carrier densities, has been often exploited in 2D devices. However, the intrinsic liquid nature of ILs, their sensitivity to humidity, and the stress induced in frozen liquids inhibit ILs from constituting an ideal platform for electrostatic gating. Here we report a lithium-ion solid electrolyte substrate, demonstrating its application in high-performance back-gated n-type MoS<sub>2</sub> and p-type WSe<sub>2</sub> transistors with sub-threshold values approaching the ideal limit of 60 mV/dec and complementary inverter amplifier gain of 34, the highest among comparable amplifiers. Remarkably, these outstanding values were obtained under 1 V power supply. Microscopic studies of the transistor channel using microwave impedance microscopy reveal a homogeneous channel formation, indicative of a smooth interface between the TMD and underlying electrolytic substrate. These results establish lithium-ion substrates as a promising alternative to ILs for advanced thin-film devices.

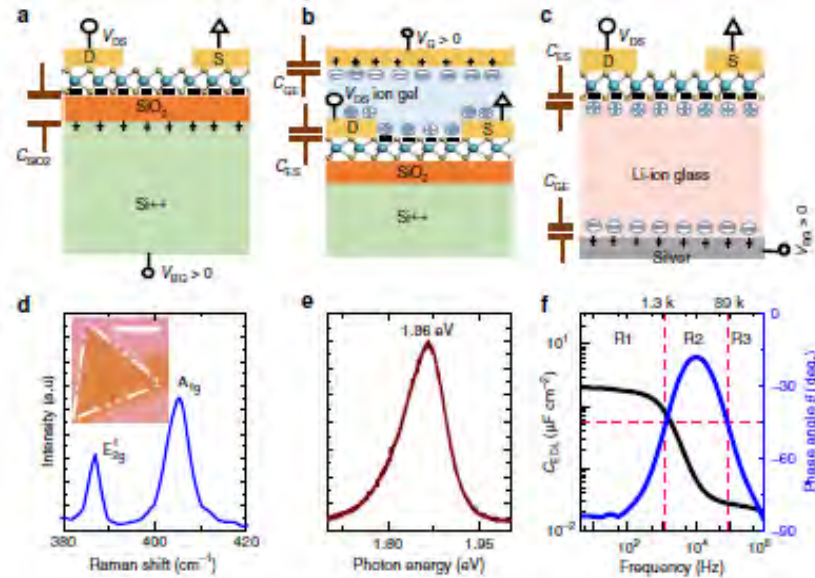

Electrostatic gating of two-dimensional (2D) materials with ionic liquids.

Md H. Alam, S. K Banerjee, K. Lai, M. Braga, D. Akinwande. Work done at Univ. of Texas Microelectronics Center.

This work was supported by NSF grant DMR-1720595. *Nature Comm.* 11(1), 2020.

National Research Priority: NSF-Quantum Leap



---

# ***NSF-Understanding the Rules of Life***

# The Surface Stress of Biomedical Silicones is a Stimulant of Cellular Response

Paszek and coworkers processed and characterized silicone gels. Such materials are commonly used for lubrication of syringes, encapsulation of medical devices, and fabrication of surgical implants. While silicones are generally viewed as relatively inert to the cellular milieu, they can mediate a variety of inflammatory responses and other deleterious effects, but the mechanisms underlying the bioactivity of silicones remain unresolved. Here, they show that silicone liquids and gels have high surface stresses that can strongly resist deformation at cellular length scales. Biomedical silicones, including syringe lubricants and fillings from FDA-approved breast implants, readily adsorb matrix proteins and activate canonical rigidity sensing pathways through their surface stresses. In 3D culture models, liquid silicone droplets support robust cellular adhesion and the formation of multinucleated monocyte-derived cell masses that recapitulate phenotypic aspects of granuloma formation in the foreign body response. Together, their findings implicate surface stress as a cellular stimulant that should be considered in application of silicones for biomedical purposes.

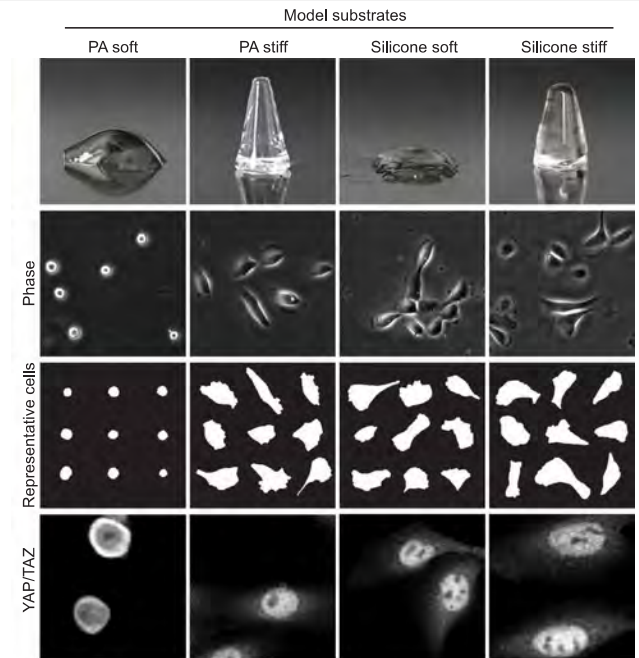

Paszek et al., Cornell. This work used the Cornell Nanoscale Facility.

This work was supported by NIH Kirschstein National Research Service Award (2T32GM008267), NIAMS K08AR068469, NCI R33-CA193043 and U54 CA210184 and DOE DEFG02-07ER46463. *Science Advances* 10 Apr 2020: Vol. 6, no. 15, eaay0076.

*National Research Priority: NSF-Understanding the Rules of Life*

# Reconfigurable nanophotonic silicon probes for sub-millisecond deep-brain optical stimulation

Lipson and collaborators fabricated an implantable silicon-based probe that can switch and route multiple optical beams to stimulate identified sets of neurons across cortical layers and simultaneously record the produced spike patterns. The use of nanophotonics to rapidly and precisely reconfigure light beams for the optical stimulation of neurons *in vivo* has remained elusive. To solve this, each switch in the device consists of a silicon nitride waveguide structure that can be rapidly ( $<20 \mu\text{s}$ ) reconfigured by electrically tuning the phase of light. By using an eight-beam probe, they show in anaesthetized mice that small groups of single neurons can be independently stimulated to produce multineuron spike patterns at sub-millisecond precision. They also show that a probe integrating co-fabricated electrical recording sites can simultaneously optically stimulate and electrically measure deep-brain neural activity. The technology is scalable, and it allows for beam focusing and steering and for structured illumination via beam shaping. The high-bandwidth optical-stimulation capacity of the device might facilitate the probing of the spatiotemporal neural codes underlying behavior.

*National Research Priority: NSF-Understanding the Rules of Life*

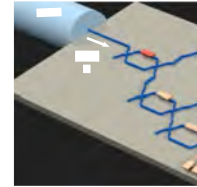

M. Lipson et al., Columbia Univ., This work used the Cornell Nanoscale Facility.

NSF Brain EAGER (1611090), NSF Graduate Research Fellowship (DGE-1144153).  
*Nature Biomedical Engineering*, (2020), 4 223–231.

# An Array Microhabitat Device to Study Nitrogen and Phosphorous Gradients in the Growth of Microalgae

Wu and collaborators fabricated an array microhabitat device with well defined dual nutrient gradients suitable for quantitative studies of microalgal cell growth. Harmful algal blooms (HABs) are an emerging environmental problem, contaminating water resources and disrupting the balance of the ecosystems. HABs are caused by the sudden growth of photosynthetic algal cells and have been expanding in extent and appearing more frequently due to the climate change and population growth. Despite the urgency of the problem, the exact environmental conditions that trigger HABs are unknown. This is in part due to the lack of high throughput tools for screening environmental parameters in promoting the growth of photosynthetic microorganisms. This device made possible delivery of 64 different nutrient conditions [nitrogen (N), phosphorous (P), and N : P ratio] at the same time, and the gradient generation took less than 90 min, advancing the current pond and test tube assays in terms of time and cost. Using a photosynthetic algal cell line, their work demonstrated the enabling capability of the microfluidic platform for screening effects of multiple environmental factors in photosynthetic cell growth, and highlighted the importance of the synergistic roles of environmental factors in algal cell growth.

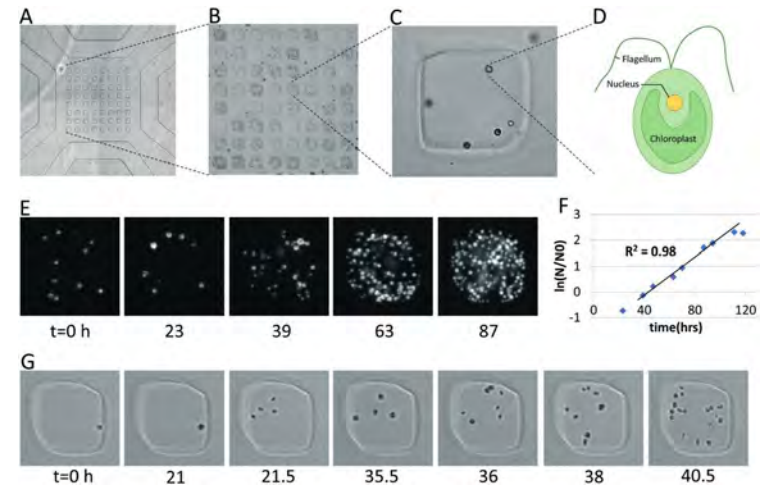

Wu et al. This work used the Cornell Nanoscale Facility.

This work was supported by USDA National Institute of Food and Agriculture, AFRI project [2016-08830], Cornell Atkinson Center for a Sustainable Future, and The New York State Hatch fund. *Lab on a Chip*, 2020, 20, 798–805.

*National Research Priority: NSF-Understanding the Rules of Life*



# Enhancement-mode Ion-based Transistor for *in vivo* Electrophysiology

Khodagholy and coworkers developed an enhancement-mode, internal ion-gated organic electrochemical transistor (e-IGT) based on a reversible redox reaction and hydrated ion reservoirs within the conducting polymer channel. Bioelectronic devices must be fast and sensitive to interact with the rapid, low-amplitude signals generated by neural tissue. They should also be biocompatible and soft, and should exhibit long-term stability in physiologic environments. Here, they developed a device which enables long-term stable operation and shortened ion transit time. E-IGT transient responses depend on hole rather than ion mobility, and combine with high transconductance to result in a gain–bandwidth product that is several orders of magnitude above that of other ion-based transistors. They used these transistors to acquire a wide range of electrophysiological signals, including *in vivo* recording of neural action potentials, and to create soft, biocompatible, long-term implantable neural processing units for the real-time detection of epileptic discharges. E-IGTs offer a safe, reliable and high-performance building block for chronically implanted bioelectronics, with a spatiotemporal resolution at the scale of individual neurons.

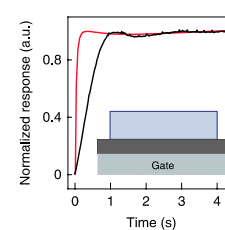
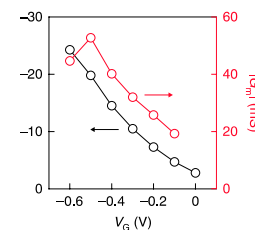
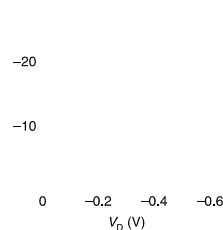
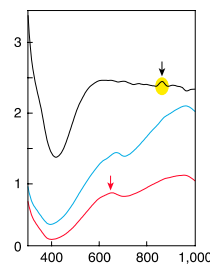

Khodagholy et al., Columbia Univ. This work used the Cornell Nanoscale Facility.

This work was supported by NIH grant (1U01NS108923-01), NSF CAREER award (1944415), CURE Taking Flight Award, Columbia School of Engineering. *Nature Materials*, (2020) 19, 679–686.

National Research Priority: NSF-Understanding the Rules of Life

# Mutant Lamins Cause Nuclear Envelope Rupture and DNA Damage in Skeletal Muscle Cells

Lammerding and coworkers built devices for the study of muscular dystrophy. Mutations in the *LMNA* gene, which encodes the nuclear envelope (NE) proteins lamins A/C, cause Emery–Dreifuss muscular dystrophy, congenital muscular dystrophy and other diseases collectively known as laminopathies. The mechanisms responsible for these diseases remain incompletely understood. Using three mouse models of muscle laminopathies and muscle biopsies from individuals with *LMNA*-related muscular dystrophy, they found that *Lmna* mutations reduced nuclear stability and caused transient rupture of the NE in skeletal muscle cells, resulting in DNA damage, DNA damage response activation and reduced cell viability. These findings implicate mechanically induced DNA damage as a pathogenic contributor to *LMNA* skeletal muscle diseases.

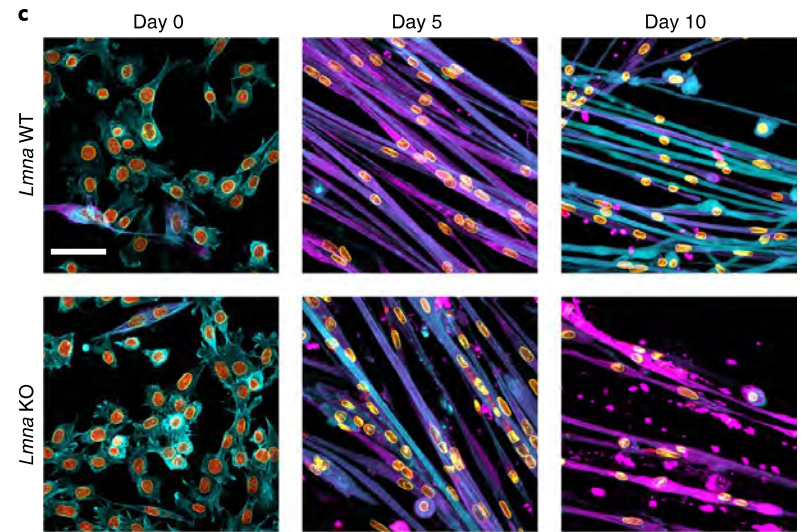

Ashley J. Earle et al., Cornell Univ. This work used the Cornell Nanoscale Facility.

This work was supported by NIH R01 HL082792 and U54 CA210184, DoD Breast Cancer Research Program (Breakthrough Award, no. BC150580, NSF(CAREER Award, CBET-1254846 and MCB-1715606), Muscular Dystrophy Association (MDA603238). *Nature Materials*, 19, 464–473 (2020).

*National Research Priority: NSF-Understanding the Rules of Life*

# Porous Zero-Mode Waveguides for Picogram-Level DNA Capture

Wanunu and coworkers developed an approach for the wafer-scale fabrication of waveguide arrays on low-cost porous membranes, which are deposited using molecular-layer deposition. They have recently shown that nanopore zero-mode waveguides are effective tools for capturing picogram levels of long DNA fragments for single-molecule DNA sequencing. Despite these key advantages, the manufacturing of large arrays is not practical due to the need for serial nanopore fabrication. In a new design the membrane at each waveguide base contains a network of serpentine pores that allows for efficient electrophoretic DNA capture at picogram levels while eliminating the need for prohibitive serial pore milling. Here, they show that the loading efficiency of these porous waveguides is up to 2 orders of magnitude greater than their nanopore predecessors.

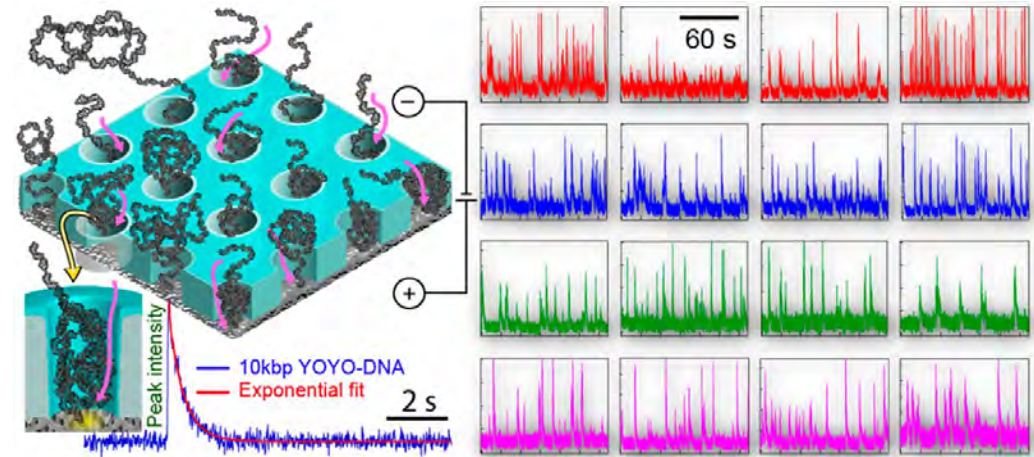

Wanunu et al., Northeastern, NIST, Pacific Biosciences. This work used the Cornell Nanoscale Facility.

This work was supported by NIH: NHGRI 1R01 HG009186. *Nano Lett.*, 19, 921–929, (2019).

*National Research Priority: NSF-Understanding the Rules of Life*



# Mechanical Stress Compromises Multicomponent Efflux Complexes in Bacteria

Hernandez and coworkers produced microfluidic devices to subject bacteria to mechanical stresses. Physical forces have a profound effect on growth morphology, locomotion, and survival of organisms. Recent findings suggest an effect of physical forces or bacterial shape, cell division, motility, virulence, and biofilm initiation, but it remains unclear how mechanical forces applied to a bacterium are translated at the molecular level. Here they manipulate tensile and shear mechanical stress in the bacterial cell envelope and use single-molecule tracking to show that octahedral shear (but not hydrostatic) stress within the cell envelope promotes disassembly of the tripartite efflux complex CusCBA, a system used by *Escherichia coli* to resist copper and silver toxicity.

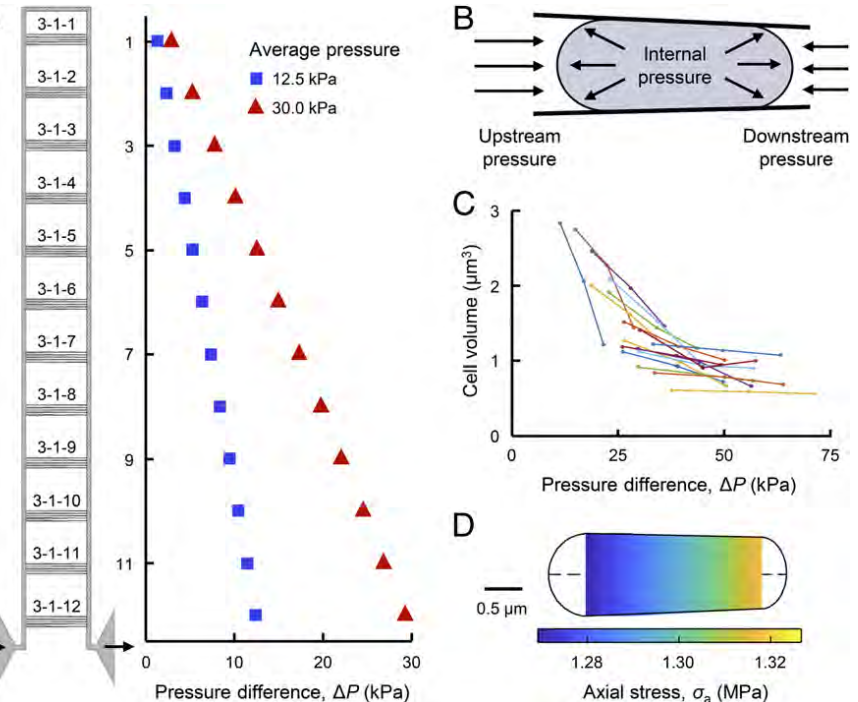

Genova et al., Cornell Univ. This work used the Cornell Nanoscale Facility.

This work was supported by ARO W911NF-19-1-0121, NSF CMMI-1463084, NIH GM109993, F31AI143208, 5T32GM008500. *PNAS*, 116 (51), 25462–25467 (2019).

*National Research Priority: NSF-Understanding the Rules of Life*



# Reversible, Barrier-Free Integration of Microfluidics and 3D Cell Culture

3D cell culture and microfluidics represent powerful tools for replicating the cell microenvironment; however, challenges in the integration of the two and compatibility with standard tissue culture protocols still represent a steep barrier to widespread adoption. Here the investigators use engineered surface roughness in the form of microfluidic channels to integrate 3D cell-laden hydrogels and fluid delivery. They designed microfluidic surfaces that enable barrier-free diffusion between the channels and the hydrogel. In addition, the sealing prevents leakage between the two components but can be reversed to facilitate recovery of the cell/hydrogel material. This method was used to culture MDA-MB-231 cells in collagen, which remained viable and proliferated while receiving media exclusively through the microfluidic channels over the course of several days.

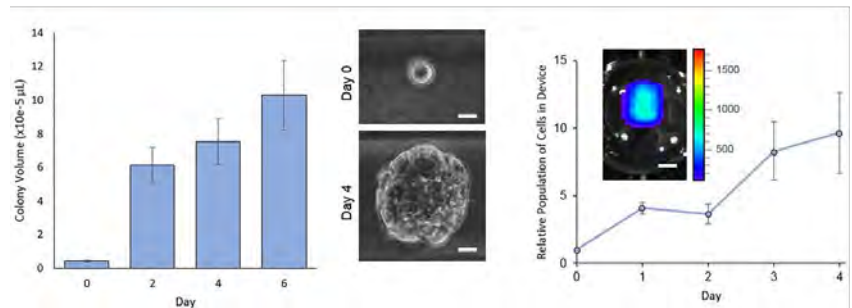
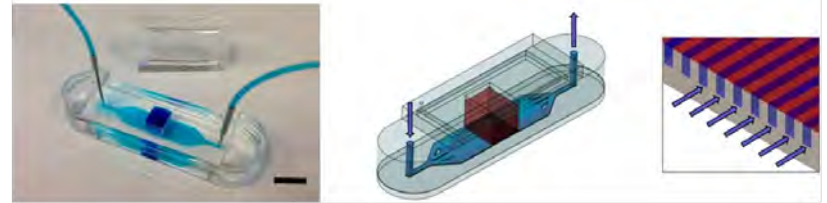

Upper: Microfluidic device for 3D cell culture. Scale bar = 10 mm. Lower: Cell viability (left) and sample removal (right) in tissue culture platform.

S. Torabi, L. Z. Li, J. Grabau, M. Sands, B. Berron, R. Xu, C. A. Trinkle, Depts. of Mechanical Engineering, Chemical and Materials Engineering, and Pharmacology and Nutritional Sciences, University of Kentucky. Work performed at the U.K. Center for Nanoscale Science and Engineering.

This research was supported by NSF Award CMMI-1125722 and NIH-NIGMS Award P20 GM121327 and appears in *Langmuir* 35, 10299–10308 (2019).

National Research Priority: NSF-Understanding the Rules of Life and Growing Convergence Research

# Development of Delivery Devices to Enable Cell Transformation or Preservation

This work focuses on developing an innovative platform technology for highly efficient intracellular delivery of molecules by integrating ultrasound and microfluidics. A major focus of this project is to deliver protective compounds to red blood cells (RBCs) in order to enable dry preservation of blood at ambient temperatures for long periods. There is currently no method that is safe and cost-effective enough for routine long-term preservation of RBCs. Therefore, an effective method to preserve RBCs in a dried state for long-term storage at ambient temperatures would solve the blood supply challenges that frequently occur. In addition, this platform technology could also be used for other applications, including dry preservation of other cells types, and high-precision non-viral transfection for CAR T and other immunotherapies.

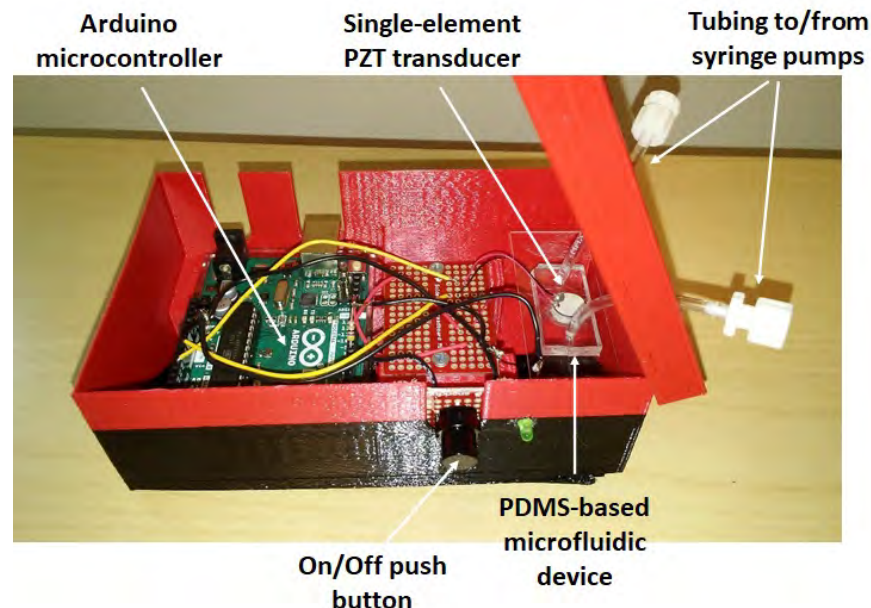

*A prototype acoustofluidic system for molecular delivery is in development. This system contains a PDMS-based flow chamber with an integrated PZT ultrasound transducer driven by an Arduino microcontroller.*

Paula Bates, Robert Keynton, Michael Menze, and Jonathan Kopechek, University of Louisville. Work performed at the University of Louisville MicroNanoTechnology Center.

NSF Award #1827521.

*National Research Priority: NSF-Understanding the Rules of Life*

# Parallel Dielectric Spectroscopy of Individual Particles using Isomotive Dielectrophoresis

This work designed, fabricated, and tested a microfluidic chip that applied an AC electric field to suspended particles. The induced dielectrophoretic forces would result in particle translation; the dielectric properties of individual particles could be extracted based on their frequency-induced trajectory. The novelty of this device was the unique curvature of the etched sidewall electrodes to produce a uniform electrokinetic force. A combination of precise deep reactive ion etching and anodic bonding was needed for successful fabrication of this microfluidic chip. Results demonstrated that isomotive dielectrophoresis was feasible and capable of conducting single cell dielectric spectroscopy. The throughput of this device is one to two orders of magnitude greater than the current technique for multi-frequency single-cell spectroscopy, electrorotation (several cells per minute compared to a few cells per hour).

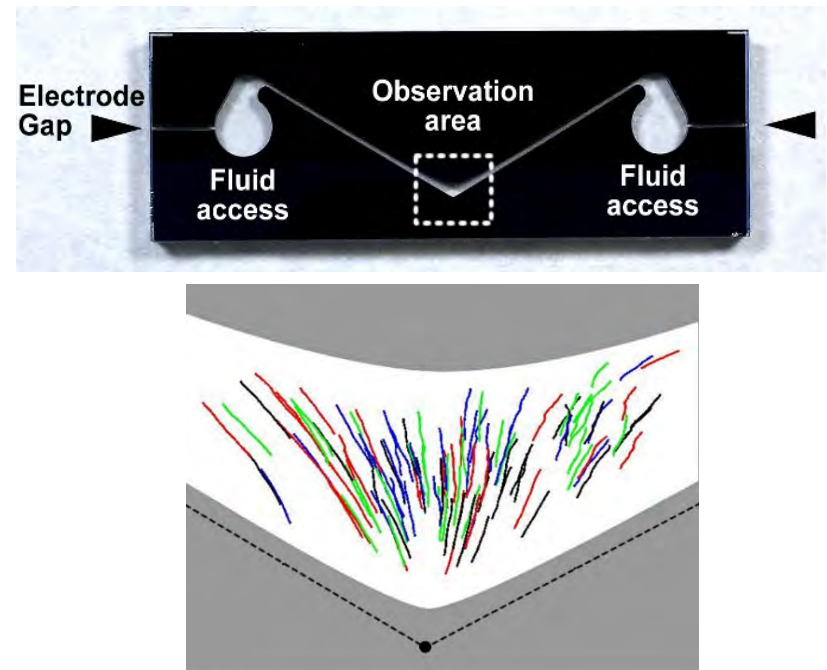

(top) Fabricated isoDEP platform. (bottom) 2D particle tracking velocimetry within the observation area of the device (overlay of multiple single-particle trials). From [1].

Stuart J. Williams, Department of Mechanical Engineering, University of Louisville. Work performed at University of Louisville's Micro/Nano Technology Center.

This research was supported by NSF Award # 1550509. *Electrophoresis*, 38, 1441 (2017), *Electrophoresis*, 41, 148 (2020), *Anal. Bioanal. Chem*, 412, 3813 (2020).

National Research Priority: NSF-Understanding the Rules of Life



# COVID-19 Related Research

The disease associated with the severe acute respiratory syndrome (SARS-CoV-2) infection has caused millions of confirmed infection cases. A rapid, accessible, and sensitive diagnosis of SARS-CoV-2 infection is critical for preventing further transmission of the disease.

In order to provide these diagnoses, researchers at Penn have leveraged the microfabrication capabilities at MANTH to fabricate microbubbling microchips and develop a microbubbling digital assay for the early diagnosis of COVID-19 by detecting SARS-CoV-2 nucleocapsid protein from respiratory swabs.

This microbubbling digital assay has the potential to be rapid (<1 h), RNA-extraction-free, smartphone accessible, and ultrasensitive. The microbubbling digital assay picolitre-sized microwells together with platinum nanoparticle labels enable the discrete “visualization” of SARS-CoV-2 N-protein molecules.

These systems are currently being validated with clinical samples and will be integrated into lab-on-a-chip devices with automated washing, signaling, reading and data processing.

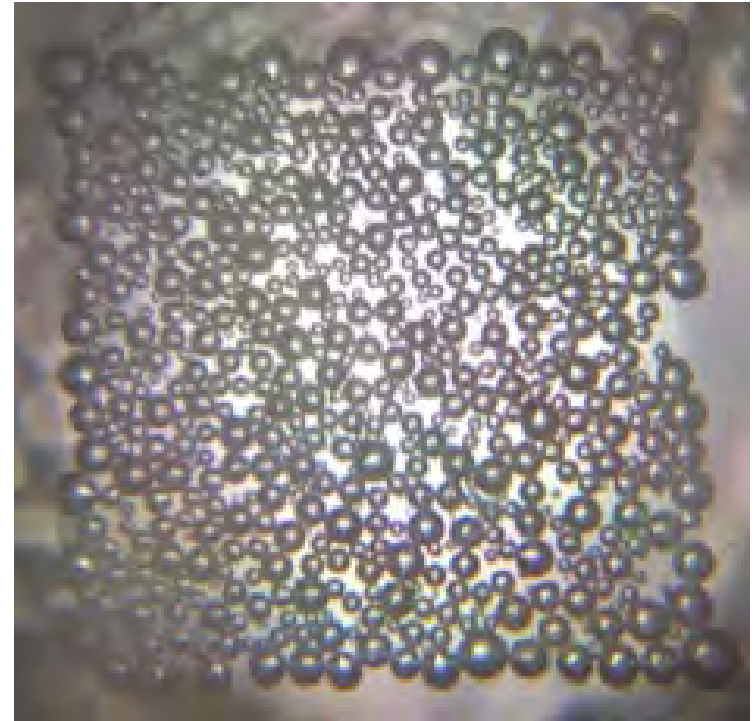

*This image shows microbubbles generated by inactivated SARS-CoV-2 viruses on our chip.*

Hui Chen and Ping Wang, Department of Pathology and Laboratory Medicine. Univ. Penn. Work was performed at MANTH.

Funding for this project was provided by the Penn Center of Precision Medicine, Penn Health-Tech and Penn Center for Innovation and Precision Dentistry. *Angew. Chem. Int. Ed.* 2019, 58, 13922 – 13928.

*National Research Priority: NSF-Understanding the Rules of Life*



# Nano IoT: A Hybrid Integrated Mechanoreceptor in 180 nm CMOS

5.4 million people in the US suffer from paralysis, which disrupts the communication between the brain and body. To restore the sense of touch to a paralyzed hand, a sensor-brain interface is proposed that performs tactile sensing using an artificial mechanoreceptor device, and the detected force information will be encoded to the brain using a neural stimulator.

The proposed artificial mechanoreceptor includes a custom capacitive tactile sensor and an interface integrated circuit. The device is low power and implantable. A base unit worn on the wrist, which includes a primary coil, will be used to generate the wireless power and collect data from the implant.

A capacitive tactile sensor based on fused silica has been developed. The sensor includes a silica upper plate with a cavity and a circular electrode as well as a silica substrate with two semi-circular electrodes, feedthroughs, and pads underneath.

The testing circuit includes an application-specific integrated circuit chip with a resolution of 22.8 fF over an input range of 100 pF for measuring capacitance of this sensor prototype. The proposed chip is implemented in a 180nm standard CMOS process.

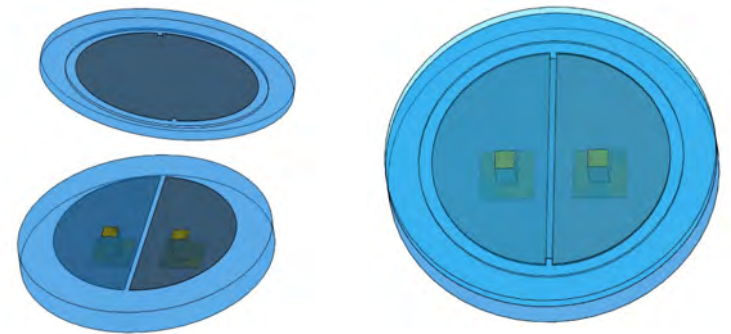
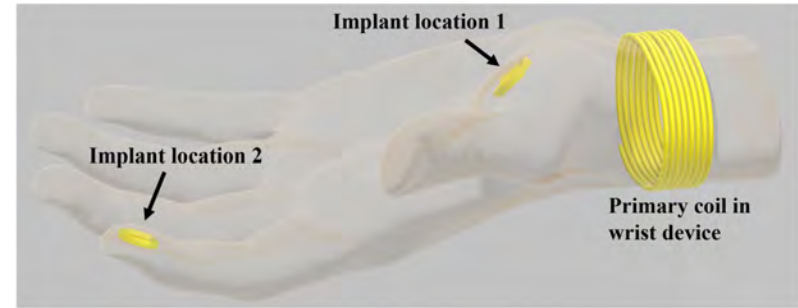

*The proposed tactile sensing system and sensor assembly diagram.*

Han Hao, Lin Du, Andrew G. Richardson, Timothy H. Lucas, Mark G. Allen, Jan Van der Spiegel, and Firooz Aflatouni, University of Pennsylvania.

*National Research Priority: NSF-Understanding the Rules of Life*

# $Ti_3C_2T_x$ for High-Density, High-Resolution Electromyography Arrays

High-density arrays of high-resolution electrodes are a valuable tool for recording the electromyogram (EMG), a biopotential representing the activation and coordination of various muscles groups within the human body. To achieve a higher spatial resolution and channel count, smaller electrodes are required, and it becomes challenging to maintain a low interface impedance and a high signal-to-noise ratio.

Two-dimensional titanium carbide MXene ( $Ti_3C_2T_x$ ) possesses remarkably high volumetric capacitance and electrical conductivity, excellent mechanical properties, and a high degree of surface functionality, and it is easy to process in aqueous solutions. Leveraging these many advantages, devices were made by a novel microfabrication process, realizing high-density, thin, and flexible  $Ti_3C_2T_x$  arrays for surface EMG recording.

They demonstrate superior performance in EMG recordings on healthy human volunteers. These results establish high-density  $Ti_3C_2T_x$  MXene arrays for recording high-fidelity, low-noise EMG, with applications in rehabilitation and sports medicine, and assistive technologies.

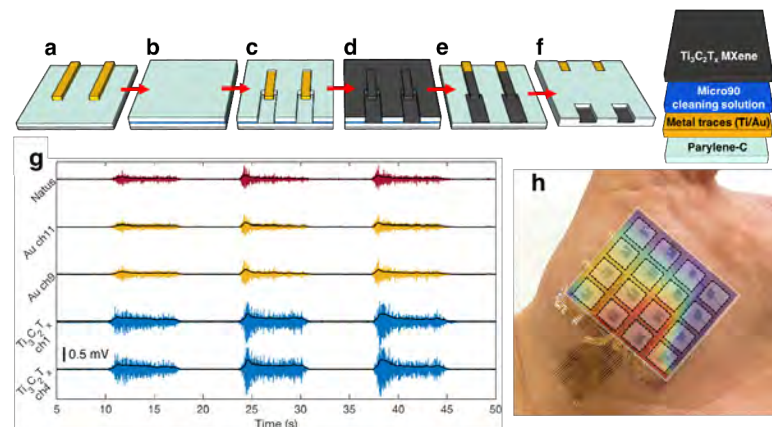

*The process flow used to microfabricate high-density  $Ti_3C_2T_x$  MXene EMG arrays at MANTH, sample traces of the EMG signals recorded using the MXene array, and demonstration of the high-density  $Ti_3C_2T_x$  MXene EMG array for millimeter-resolution recording of muscle activation.*

Flavia Vitale, Penn Department of Neurology, Bioengineering and Physical Medicine and Rehabilitation, with Brendan B. Murphy, Patrick J. Mulcahey, Nicolette Driscoll, Andrew G. Richardson, Gregory T. Robbins, Nicholas V. Apollo, Kathleen Maleski, Timothy H. Lucas, Yury Gogotsi, and Timothy Dillingham, from the Penn Department of Bioengineering, the Penn Department of Neurosurgery, Penn Medicine, and the Materials Science and Engineering Department at Drexel University.

*National Research Priority: NSF-Understanding the Rules of Life*

# Therapeutic Articulations, LLC (External User Research)

Dawn Gulick, founder of Therapeutic Articulations says “Orthopedics is about precision. The Mobil-Aider device is able to quantify knee joint laxity to contribute to the clinical decision-making regarding injury management.”

The development of the Mobil-Aider device to measure joint mobility continues with the assistance of a Phase II National Science Foundation SBIR grant.

The reliability and validity of the measurements via bench and clinical testing has been confirmed. The Zeiss Smartzoom microscope, located at MANTH, was used as the standard to assess the ability of the Mobil-Aider™ to measure linear translation. Sixty blinded measures were taken with each of six different Mobil-Aider™ devices indicating a strong correlation between the measures.

A case report using radiographs to assess linear translation of the knee with the Mobil-Aider™ revealed that the radiographic images and the Mobil-Aider™ results show a difference of only 2%. Further clinical testing has begun on individuals with anterior cruciate ligament (ACL) injuries.



*A rendering of Mobil-Aider Device.*

Dawn Gulick, Widener University

Funded in part by NSF SBIR 1923614. *International Journal of Sports and Exercise Medicine*. June 2019 Article ID: IJSEM-5-132.

*National Research Priority: NSF-Understanding the Rules of Life*



# Graphene Acoustic Plasmon Resonator for Ultrasensitive Infrared Spectroscopy

A fundamental hurdle in plasmonics is the trade-off between electromagnetic field confinement and the coupling efficiency with free-space. Here, we show that this fundamental compromise can be overcome and demonstrate a graphene acoustic plasmon resonator with nearly perfect absorption (94%) of incident mid-infrared light. This is achieved with a two-stage coupling scheme. To do this we transfer unpatterned large-area graphene onto template-stripped ultraflat metal ribbons. An integrated optical spacer and a reflector increase the enhancement. Graphene acoustic plasmons allow ultrasensitive measurements of absorption bands and surface phonon modes in ångström-thick protein and SiO<sub>2</sub> layers, respectively. This platform can harness the ultimate level of light-matter interactions for applications including spectroscopy, sensing, metasurfaces and optoelectronics.

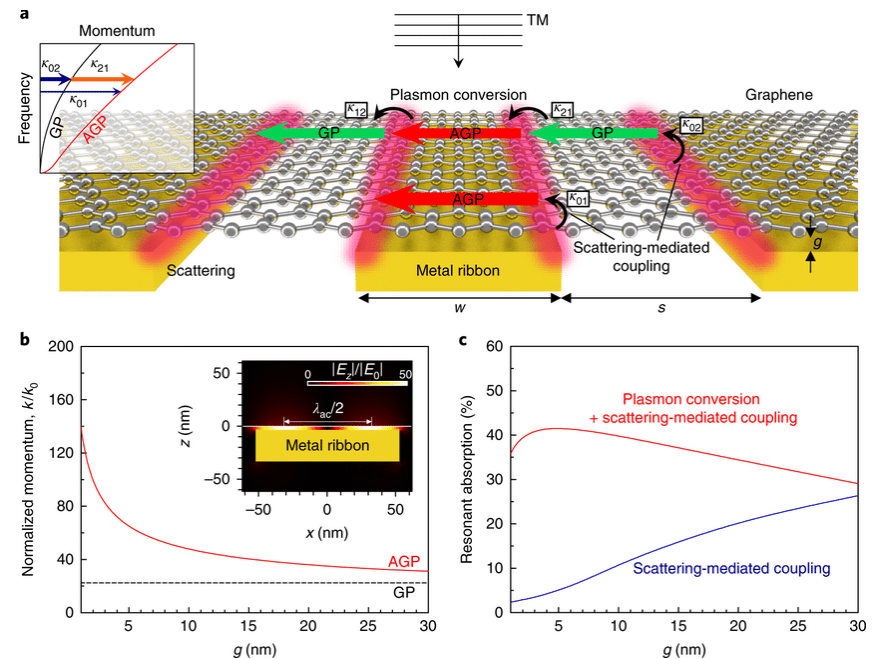

a) Schematic illustration of the acoustic plasmon resonator architecture. Red and green arrows represent acoustic GPs and conventional GPs, respectively.  $k_{ij}$  denotes the coupling and  $g$  is the gap distance. b) Gap dependence of AGP plasmon momentum normalized to the free-space momentum at  $8\ \mu\text{m}$ . c, Resonant absorption as a function of gap size.

In-Ho Lee, Daehan Yoo, Phaedon Avouris, Tony Low, Sang-Hyun Oh. Work performed at Minnesota's Nano Center.

*Nature Nanotechnology*, 14, 313-319, 2019.

National Research Priority: NSF-Understanding the Rules of Life



# Electrophoretic exclusion microscale sample preparation for cryo-EM structural determination of proteins:

Noting that relatively few bioparticles are needed to generate high quality protein structures, this work uses microfluidics that can accurately and precisely manipulate and deliver bioparticles to grids for transmission electron microscopy. The use of microfluidics enables isolation, purification, and concentration of specific target proteins at these small scales and does so in a relatively short period of time (minutes). These capabilities enable imaging of more dilute solutions and obtaining pure protein images from mixtures. In this system, spatially isolated, purified, and concentrated proteins are transferred directly onto electron microscopy grids for imaging. The processing enables imaging of more dilute solutions, as low as  $5 \times 10^{-6}$  g/ml, with small total amounts of protein (<400 pg, 900 amol). These levels may be achieved with mixtures and, as proof-of-principle, imaging of one protein from a mixture of two proteins is demonstrated.

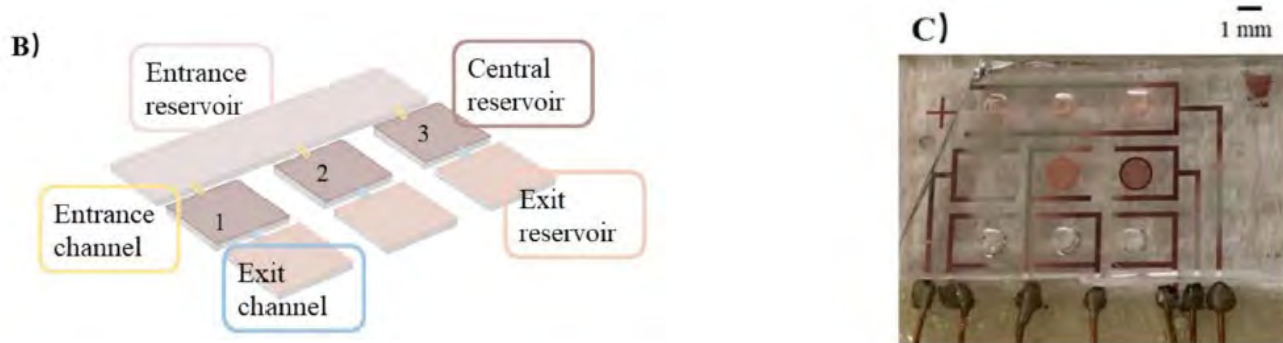

B) General layout of device with various elements and zones labeled. At the entrance and exit of each connecting channel, electrodes are placed to generate a field within the channel and not the reservoirs. (c) Image of the actual device including reservoirs, electrodes, interconnects, access ports, and embedded EM grids.

Mark Hayes, School of Molecular Sciences, Arizona State University. Work performed at NCI-SW.

National Research Priority: NSF-Understanding the Rules of Life

# Rod-shape theranostic nanoparticles facilitate antiretroviral drug biodistribution and activity in human immunodeficiency virus susceptible cells and tissues

In this work, the NNF external user Bhavesh Kevadiya and co-workers created multimodal rilpivirine (RPV) lutetium labeled bismuth sulfide nanorods ( $^{177}\text{LuBSNRs}$ ), then investigated its biological responses, adverse reactions and used the NNF to evaluate its structure, morphology, configuration and chemical composition. Human immunodeficiency virus theranostics facilitates the development of long acting (LA) antiretroviral drugs (ARVs) by defining drug-particle cell depots. Through the creation of rod-shaped particles of defined sizes reflective of native LA drugs, theranostic probes can be deployed to measure particle-cell and tissue biodistribution, antiretroviral activities and drug retention. Nanoformulated RPV and BSNRs-RPV particles showed comparable physicochemical and cell biological properties. Drug-particle pharmacokinetics (PK) and biodistribution in lymphoid tissue macrophages proved equivalent, one with the other. Rapid particle uptake and tissue distribution were observed, without adverse reactions, in primary blood-derived and tissue macrophages. The latter was seen within the marginal zones of spleen.

B D Kevadiya, B Ottemann, I Z Mukadam, L Castellanos, K Sikora, J R Hilaire, J Machhi, J Herskovitz, D Soni, M Hasan, W Zhang, S Anandakumar, J Garrison, JoEllyn McMillan, B Edagwa, R L Mosley, R W Vachet, H E Gendelman. College of Medicine, UNMC Omaha. Work performed in part at the Nebraska Nanoscale Facility.

*Theranostics*, 10, 630, 2020.

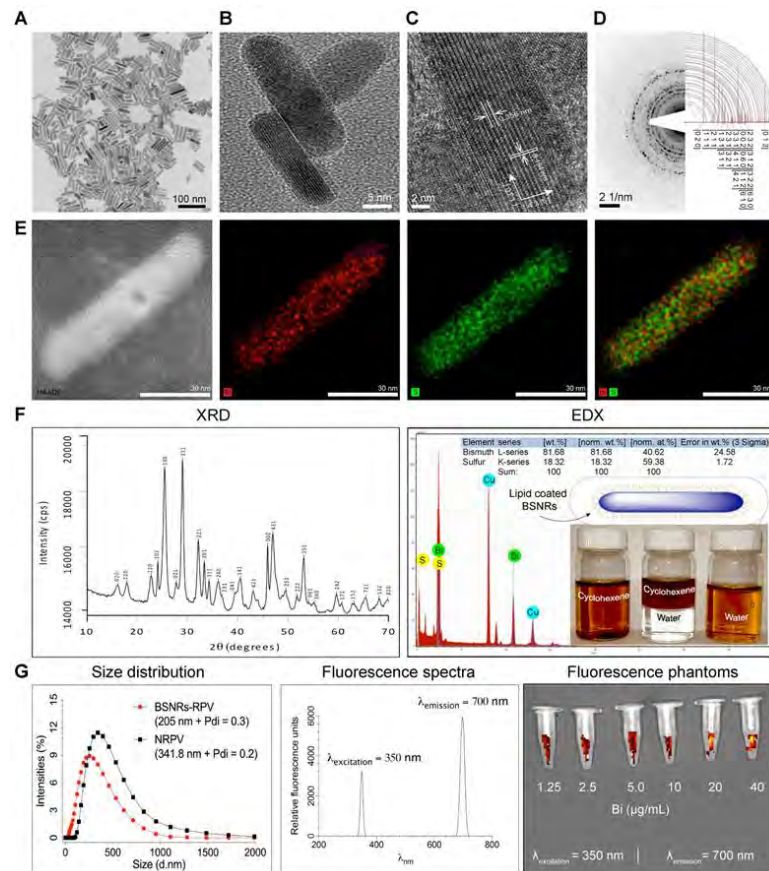

Synthesis and characterization of multimodal particles. TEM, EDX, XRD, size distribution and fluorescence.

National Research Priority: NSF-Understanding the Rules of Life

# Quantifying nitrogen assimilation in the deep ocean

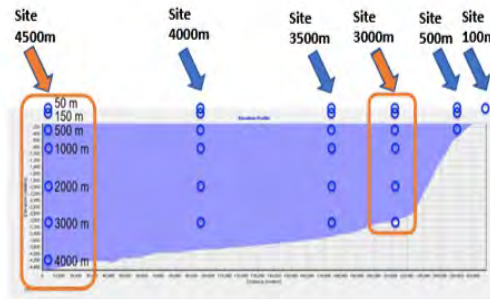
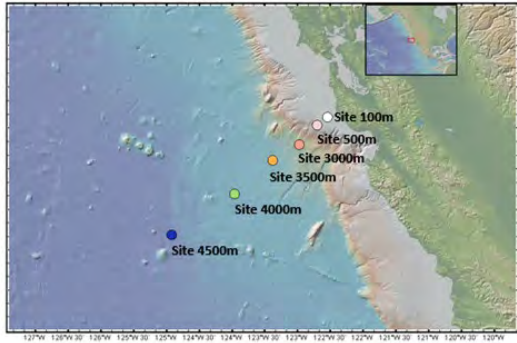

NanoSIMS analysis: measuring single cell activity

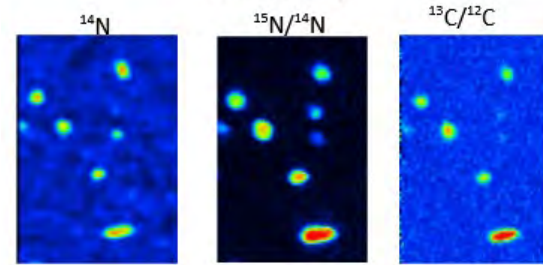

Nitrogen is a key element for microbial activity in the oceans, and while dinitrogen gas ( $\text{N}_2$ ) is abundant on the surface of the water, it is inaccessible for most microbes. Therefore, nitrogen fixation (conversion of  $\text{N}_2$  to  $\text{NH}_3$ ) is critical for marine ecosystems, and both ammonia and urea are available in the oceans as nitrogen sources. To quantify the contribution of these nitrogen sources in different parts of the ocean, samples were collected at different locations and depths off the coast of Northern California and the level of nitrogen assimilation was quantified by secondary ion mass spectrometry.

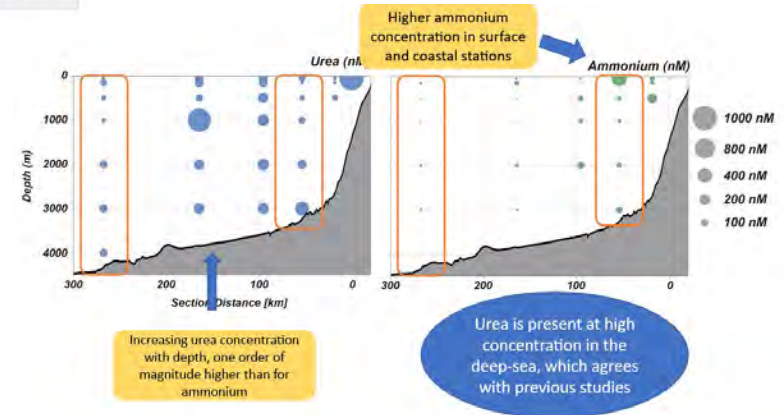

Nestor Arandia-Gorostidi, Alma E. Parada, Alexandra R. Bausch, Anne E. Dekas, Earth System Science, Stanford University. Work performed at Stanford Nano Shared Facilities, nano@stanford site.

This work was supported by NSF Award # ECCS-1542152.

*National Research Priority: NSF-Understanding the Rules of Life*



# Peptoid-Directed Assembly of CdSe Nanoparticles

Peptoids offer an organic scaffold very similar to proteins, but with a wider solubility range and easily tunable side chains and functional groups to create a variety of self-assembling architectures with atomic precision. In this work, peptoid tubes and sheets were explored as platforms to assemble colloidal quantum dots (QDs) and clusters. We synthesized CdSe QDs with difunctionalized capping ligands containing both carboxylic acid and thiol groups and mixed them with maleimide containing peptoids, to create an assembly of the QDs on the peptoid surface via a covalent linkage. This conjugation was seen to be successful with peptoid tubes, sheets and CdSe QDs and clusters. The particles were seen to have a high preference for the peptoid surface with control over QD density as a function of maleimide concentration.

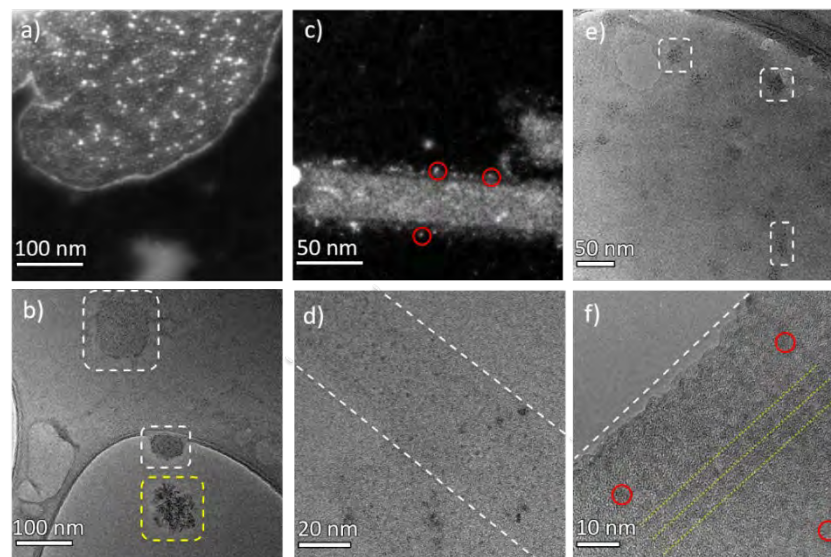

(a, b) Cys-CdSe QDs exhibit a strong preference for binding to maleimide-functionalized peptoid sheets. (c,d) Peptoid tubes conjugated with CdSe QDs, seen along the tube edges (red circles), with high preference and uniform distribution. (e,f) CdSe clusters conjugated with a peptoid sheets (e) and tubes (f). (f) Clusters (red) are seen exhibiting linear trends (yellow dotted lines) parallel to the tube edge. Peptoid edges denoted by white dashed lines.

Madison Monahan, Bin Cai, Tengyue Jian, Shuai Zhang, Guomin Zhu, Chun-Long Chen, James De Yoreo, Brandi M. Cossairt, Depts. of Chemistry, Materials Science and Engineering, Chemical Engineering, Univ. of Washington, Pacific Northwest National Laboratory Physical Sciences Division. Work performed at the Molecular Analysis Facility (MAF).

This work was supported by US DOE, Office of Science, Office of Basic Energy Sciences DE-SC0019288.



National Research Priority: NSF-Understanding the Rules of Life

National Nanotechnology  
Coordinated Infrastructure



NORTHWEST  
NANOTECHNOLOGY  
INFRASTRUCTURE



# Pathways of Concern for Chronic Microplastics Exposure in Adult Fish

Work conducted to better understand the risk of microplastic consumption to adult Japanese medaka (a species of fish)

Fish fed diets containing polystyrene microplastics during maturation from juvenile to adult

SEM localized these microplastics to gills and digestive tract

Cell number and morphology indicated an acute response to these irritants

Use of SEM revealed responses not visible with other methods (e.g. histology)

Mei Zhu, Melissa Chernick, Daniel Rittschof, and David Hinton. Nicholas School of the Environment, Duke University. Work performed at Duke's Shared Materials Instrumentation Facility.

Work supported by the Oak Foundation. *Aquat. Toxicol.*, 220 (2020).

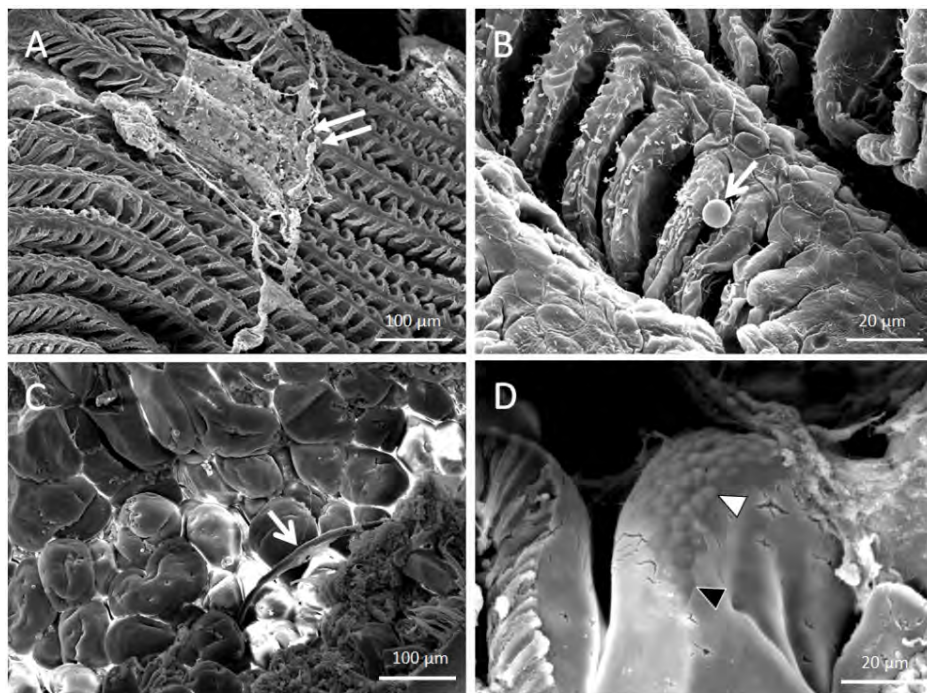

SEM images of Japanese medaka gills (A-B) and gut (C-D) exposed to microfibers or microplastics

Arrows indicate: mucous sheets (A), spherical polystyrene microplastic (B), polyester microfiber (C), swollen enterocytes (white, D) and erosion of brush border (black, D) on apex of gut fold

National Research Priority: NSF-Understanding the Rules of Life

# Rise of Terrestrial Vertebrates during the Triassic Period

During the Triassic Period (252-200 million years ago), terrestrial vertebrates transformed from the “alien” to the more familiar (e.g. amphibians, mammal relatives, reptiles)

Chronicling this transformation is challenging due to lack of robust anatomical information

This work focuses on Triassic faunas that have living members (e.g. mammals, birds) as well as those that evolved and went extinct (e.g. early dinosaurs)

Using computed tomography (CT) to characterize fragile specimens encased in rock

Identified some of world’s oldest amphibians and will use this technique to better understand evolution of ecological shifts in reptiles

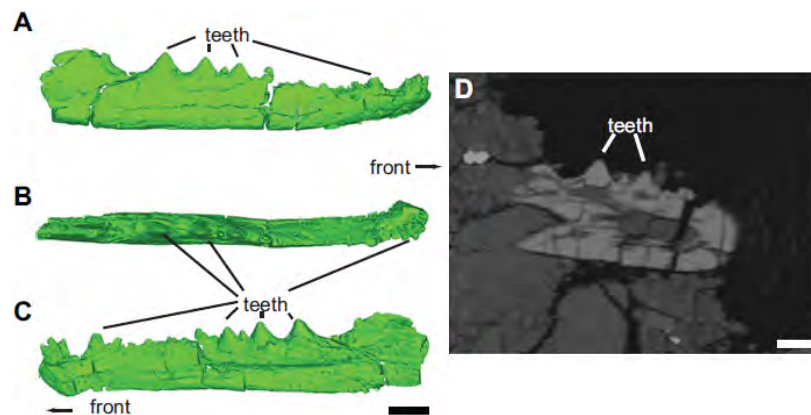

3D reconstructions of a delicate and rare reptile jaw from the Triassic in lateral (A), occlusal (B), and medial (C) views generated from high quality CT data (D). Scale bars = 1 mm

Brenen Wynd, Sterling Nesbitt, Michelle Stocker, and Andrew Heckert., Joint Department of Geosciences, Virginia Tech. Work performed at Duke’s Shared Materials Instrumentation Facility.

Work supported by Virginia Tech Geosciences Charles J. Gose Research Award in addition to the John A. and Katherine G. Jackson School of Geosciences and the Geology Foundation at the University of Texas Austin. *J. Vertebr. Paleontol.* 39 (2020).



CT scan of Triassic frog ilium (hip bone)

National Research Priority: NSF-Understanding the Rules of Life

# 3D Imaging Cell Analysis with Artificial Intelligence

## Scientific and engineering significance:

NanoCollect applies the convolutional neural network (CNN) analysis to 3D cell tomography obtained from a unique imaging flow cytometer. Cell classification and cell type discovery play central roles in understanding the fundamental rules governing the developments and functions of all lives. The studies also help our understanding of the mechanisms for biological animalities and pathological conditions. The development of the tools and methodologies integrates the fields of photonics, fluid mechanics, cell biology, electronics, and artificial intelligence, exemplifying convergence research with direct impact on the pursuit of rules of life.

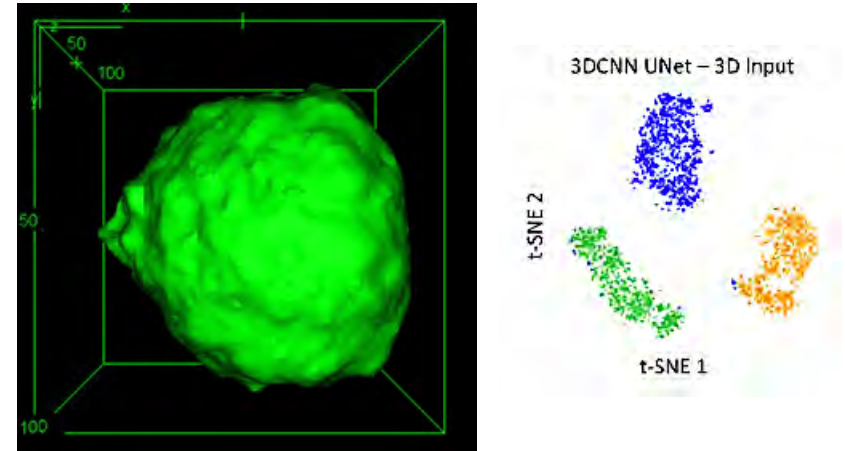

*NanoCollect high throughput (10,000X faster than confocal microscopy) biological single cell analysis based on artificial intelligence.*

The work was developed by NanoCollect Biomedical, a startup company pioneering in the field of microfluidic cell analysis for drug discovery, gene editing, immunotherapy, and single cell genomics, with its system sold in 16 countries and used by leading biomedical research labs and industry. SDNI plays an essential role in its development of the microfluidics platform and production of its commercial prototype.

*National Research Priority: NSF-Understanding the Rules of Life and NSF-Convergence Research*



# Niche-Responsive Nanocarriers for Immunotherapeutic Delivery

The **SQI Peptide Synthesis Core** was utilized by the Kibbe lab at the University of North Carolina for the design and synthesis of peptide amphiphiles (PAs) used in this study. PAs were designed to target tissue factor (TF), a protein present in blood vessels, but only exposed after external damage. The goal was to develop a PA that could selectively and specifically localize to areas of active hemorrhage, making TF a suitable target.

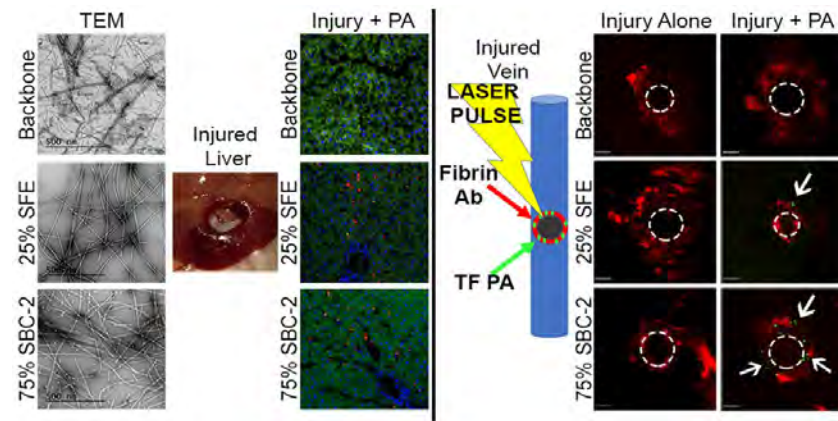

Targeted peptide amphiphiles (PAs) form cylindrical fibers (left) that selectively target areas of active hemorrhage in rat liver (middle) and mouse leg (right).

Klein<sup>†</sup>, Kassam<sup>†</sup>, Lee<sup>†</sup>, Bergmeier<sup>†</sup>, Peters<sup>†</sup>, Gillis<sup>†</sup>, Dandurand<sup>†</sup>, Rouan<sup>†</sup>, Karver<sup>\*</sup>, Struble<sup>\*</sup>, Clemons<sup>\*</sup>, Palmer<sup>\*</sup>, Pritts<sup>‡</sup>, Tsihlis<sup>†</sup>, Stupp<sup>\*‡</sup>, and Kibbe<sup>†</sup>, <sup>\*</sup>SQI, Northwestern, <sup>†</sup>Surgery, Center for Nanotechnology in Drug Delivery, Biomedical Engineering, UNC, <sup>‡</sup>Surgery, University of Cincinnati, <sup>‡</sup>Chemistry, Medicine, Biomedical Engineering, Northwestern University. This work utilized the SQI and NUANCE at SHyNE.

This work was supported by NSF ECCS-1542205, DOD AFRL/RQKHC #FA8650-16-2-6G19, NIH #1R01HL116577-0/1R35HL144976-0, NC Hematology NIH T32 Training Grant #HL007149-42. ACS Nano 14 (6), 6649-6662.

National Research Priority: NSF-Understanding the Rules of Life



# Controlled and extended drug release from Nanonet-nano fibers

In this work, for the first time nanonet-nanofiber electrospun meshes (NNEMs) of polycaprolactone (PCL)-chitosan (CH) were synthesized using electrospun nanofiber technology. The fabricated NNEMs were utilized for high payload delivery and controlled release of a water-soluble drug, namely Diclofenac Sodium (DS). High drug entrapment efficiency and concentration-dependent drug release patterns were investigated for up to 14 days. Results showed that the DS drug is a key contributing factor in the generation of nanonet-nanofiber networks during electrospinning. DS-NNEMs also enhanced cell adhesion, viability, and proliferation in the nanonet-nano fiber network through the controlled release of DS.

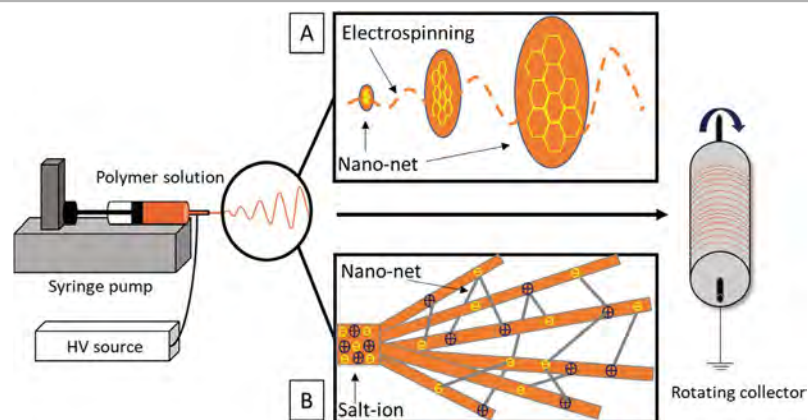

Schematic of a possible mechanism for nano-net formation

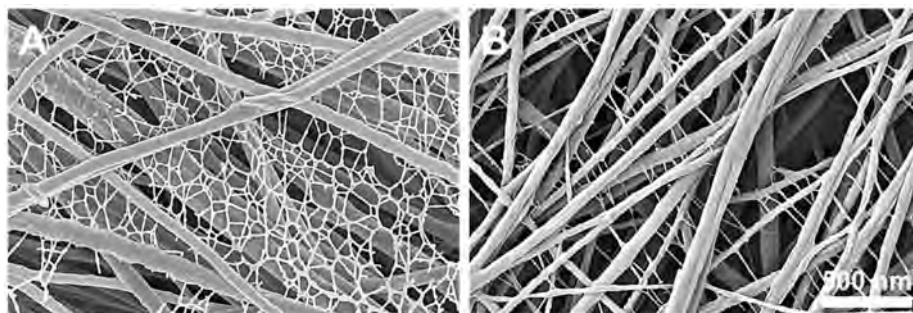

Nanonet electrospun mesh fiber. (A) Spider-nets with phase separation and (B) branched nano-net produced between the main fibers

Sheikh Saudi, Narayan Bhattarai et al., North Carolina A&T State University. Part of this work was performed at the Joint School of Nanoscience and Nanoengineering.

This work was supported by NSF Award# EEC-0812348. Nanoscale, 2020.

National Research Priority: NSF-Understanding the Rules of Life

# Investigation of gastrointestinal integrity on exposure to metal, metal oxide, and metal sulfide nanoparticles

Using fully differentiated Caco-2 cells, the perturbation of intestinal barrier function and cytotoxicity were investigated for 20 metal, metal oxide, and metal sulfide nanoparticles (NPs). Caco-2 cells were exposed to 50  $\mu\text{g}/\text{mL}$  NPs for 24 h. NP formulations were characterized at 0 and 24 h, and In Vitro Sedimentation, Diffusion and Dosimetry Modeling was applied to calculate the effective dose of exposure during 24 h. Our results illustrate that while many metal, metal oxide, and metal sulfide ENMs do not adversely affect monolayer integrity or induce cytotoxicity in differentiated Caco-2 cells, a subset of ENMs may compromise the intestinal integrity. This study demonstrated the use of differentiated Caco-2 monolayer and  $P_{app}$  as an endpoint to identify and prioritize ENMs that should be investigated further.

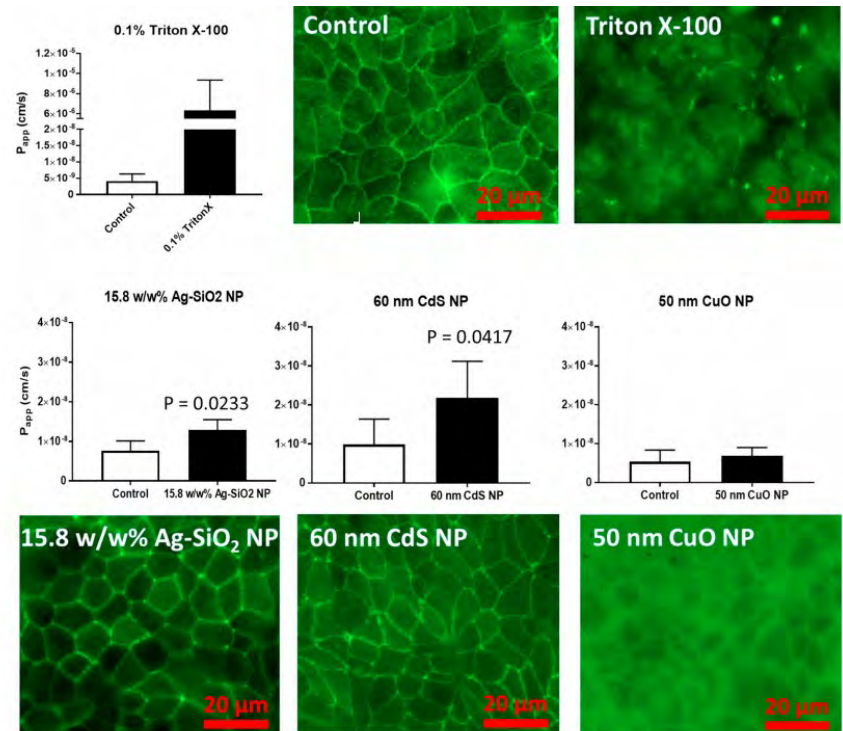

Apparent permeability coefficient ( $P_{app}$ ) of AF488-dextran (3,000 Da) and tight junction (ZO-1) staining following 24 hours exposure to NPs

Mortensen, Fennell et al., RTI International. Work performed at Joint School of Nanoscience and Nanoengineering.

This work was supported by NIH grant # U01ES027254 and NSF Award# CBET- 1604647. *NanoImpact*, 17, 100212, 2020

National Research Priority: NSF-Understanding the Rules of Life

# Fully Wireless, Nanostructured, Hemodynamic Sensor System for Continuous Monitoring of Blood Pressure and Flow Rate

Hemodynamic conditions are used as indications for cardiovascular diseases, which account for over 30% of deaths worldwide

Focused on developing an implantable smart stent with two nanostructured, soft pressure sensors for wireless monitoring of blood pressure and flow rate

Stent is balloon expandable and employs a solenoid-like shape with polymer support links to maintain mechanical integrity and a high inductance (1.4  $\mu\text{H}$ )

Fully printed, low-profile capacitive pressure sensors use a microstructured PDMS dielectric layer to achieve high sensitivity (3.8 fF/mmHg).

Future work will include wireless testing and in vivo demonstration

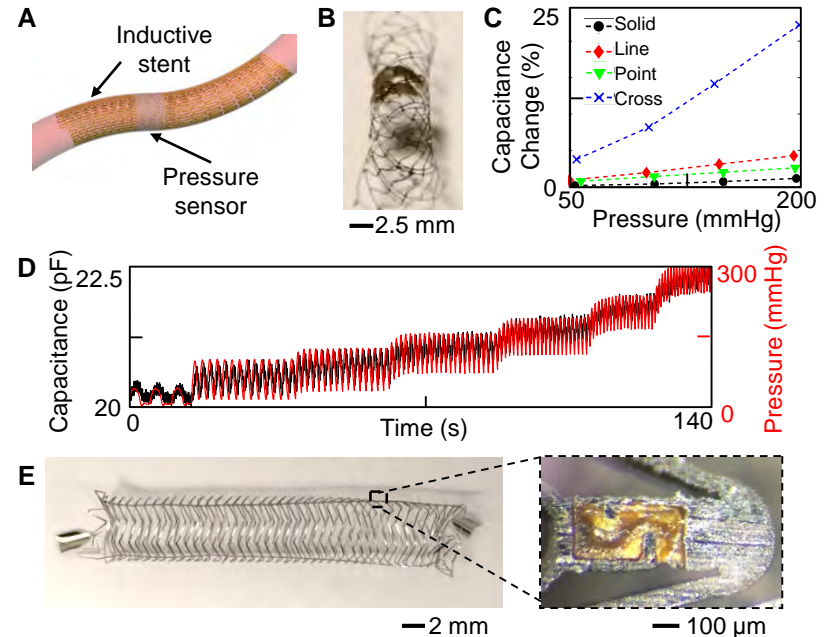

A) Illustration of implantable smart stent and sensor. B) Low-profile pressure sensor integrated on stent. C) Pressure sensitivity comparison of PDMS microstructures. D) Pressure sensor response to pulsatile flow in model blood vessel. E) Smart stent after balloon expansion with enlarged view of polyimide support link.

Robert Herbert and Woon-Hong Yeo, Mechanical and Biomedical Engineering, Georgia Institute of Technology. Work performed at Georgia Tech's Institute for Electronics and Nanotechnology.

This work was partially supported by a SENIC Seed Grant (NSF ECCS-1542174).

National Research Priority: NSF-Understanding the Rules of Life



# Nano-colloid Facilitated Transport of Organic Carbon Release from Riparian Sediment

In aqueous systems, nano-colloids (1-100 nm diameter) and small colloids (<450 nm diameter) provide a vast store of surfaces to which organic carbon (OC) can sorb, precluding normal bioavailability. As such, mineral nano-colloids (MNC) and small colloids, are both an unaccounted-for reservoir and unquantified vector for transport of OC and nutrients and contaminants within watersheds. Colloids extracted from two contrasting riparian sediments analyzed using STEM/EDS displayed aggregations with high concentrations of Si, Al, and O, suggesting that these are primarily silicate minerals.  $\mu$ -XRD patterns were crystalline with sharp peaks for kaolinite. Mössbauer spectra revealed ~80% of the sample's Fe was nano-particulate goethite (<10 nm) and confirmed the presence of hematite, with <3% Fe being hematite.

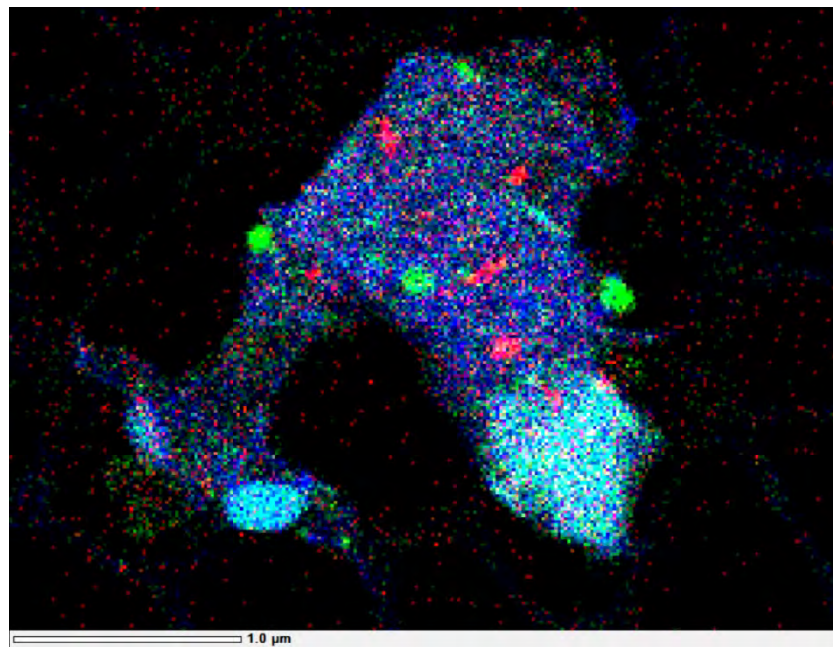

STEM / EDS mapping of aerobic water extracted colloids from Tims Branch within the Savannah River watershed, near Aiken South Carolina, Si (blue), Al (green), Fe (red).

K. Rod, K. Patel, S. Kumar, E. Cantando, W. Leng, R. Kukkadapu, O. Qafoku, M. Bowden, D. Kaplan, and K. Kemner, Washington State Dept. of Ecology. Work partially performed at Pacific Northwest National Lab and Virginia Tech National Center for Earth and Environmental Nanotechnology (NanoEarth).

This work was supported by NSF Award # ECCS-1542100 and 2025151.

*National Research Priority: NSF-Understanding the Rules of Life*



---

# ***NSF-Growing Convergence Research***

# Bidirectional Self-Folding with Atomic Layer Deposition Nanofilms for Microscale Origami

Cohen and collaborators carried out origami-inspired fabrication of nanoscale sheets by engineering bidirectional folding with 4 nm thick atomic layer deposition (ALD) SiN<sub>x</sub>-SiO<sub>2</sub> bilayer films. Origami design principles are scale invariant and enable direct miniaturization of origami structures provided the sheets used for folding have equal thickness to length ratios. Recently, seminal steps have been taken to fabricate microscale origami using unidirectionally actuated sheets with nanoscale thickness. Strain differentials within these bilayers result in bending, producing microscopic radii of curvature. They lithographically pattern these bilayers and localize the bending using rigid panels to fabricate a variety of complex micro-origami devices. Upon release, these devices self-fold according to prescribed patterns. Their approach combines computerized origami design, making it easy to fabricate and deploy such microstructures *en masse*. These devices represent an important step forward in the fabrication and assembly of deployable micromechanical systems that can interact with and manipulate micro- and nanoscale environments

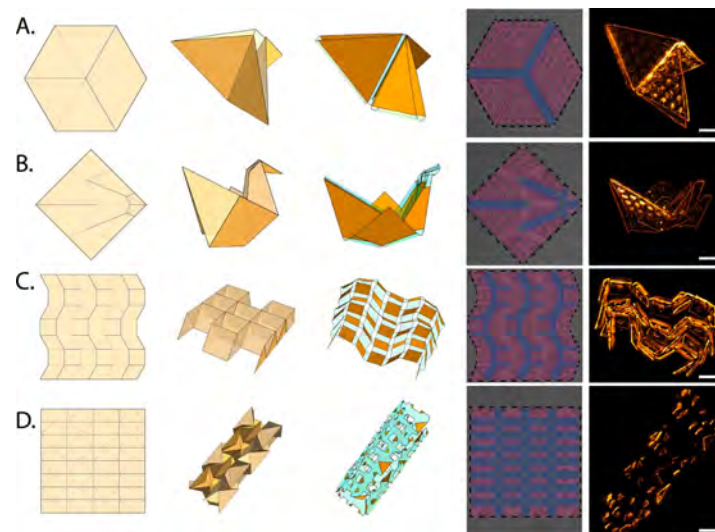

Cohen et al., Cornell. This work used the Cornell Nanoscale Facility.

This work was supported by ARO W911NF-18-1-0032, NSF MRSEC program (DMR-1719875). *Nano Lett.* 2020, 20, 4850–4856.

*National Research Priority: NSF-Growing Convergence Research (2D Materials)*

# Gallium Nitride Tunneling Field-effect Transistors Exploiting Polarization Fields

Xing, Rana and coworkers showcased a vertical tunnel field effect transistor (TFET) fabricated from a GaN/InGaN heterostructure and compared it to a gated vertical GaN p-n diode. By including a thin InGaN layer, the interband tunneling in the TFET is increased compared to the gated homojunction diode. This leads to an increased drain current of 57 IA/Im and a reduced subthreshold swing of 102 mV/dec, from 240 mV/dec. However, trap assisted tunneling prevents devices from realizing subthreshold slopes below the Boltzmann limit of 60 mV/dec. Nevertheless, this work shows the capability of tunnel field effect transistors to be realized in GaN by taking advantage of the spontaneous and piezoelectric polarization in the III-N material system.

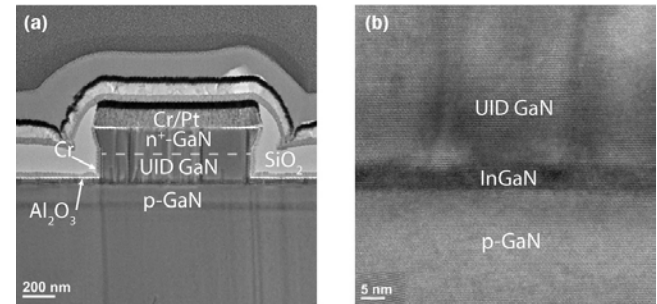

Xing, Jena et al. This work used the Cornell Nanoscale Facility.

This work was supported by LEAST, one of the six SRC STARnet Centers, sponsored by MARCO and DARPA. *Appl. Phys. Lett.* 116, 073502 (2020); doi: 10.1063/1.5132329

*National Research Priority: NSF-Growing Convergence Research (Microelectronics)*

# All-Glass, Large Metalens at Visible Wavelength Using Deep-Ultraviolet Projection Lithography

Capasso and coworkers created metalenses, planar lenses realized by placing subwavelength nanostructures that locally impart lenslike phase shifts to incident light. Such lenses are promising as a replacement for refractive optics for their ultrathin, lightweight, and tailorable characteristics, especially for applications where payload is of significant importance. In this Letter, they demonstrate a centimeter-scale, all-glass metalens capable of focusing and imaging at visible wavelength, using deep-ultraviolet (DUV) projection stepper lithography. We further explore the imaging capabilities of our metalens using a color-pixel sCMOS camera and scanning-imaging techniques, demonstrating potential applications for virtual reality (VR) devices or biological imaging techniques.

Capasso et al., Harvard Univ. This work used the Cornell Nanoscale Facility.

This work was supported by DARPA HR00111810001. *Nano Letters* 2019 19 (12), 8673-8682.

*National Research Priority: NSF-Growing Convergence Research (Photonics)*



# A Polarization-induced 2D Hole Gas in Undoped Gallium Nitride

Muller, Xing, Jena and coworkers produced a nitride semiconductor device that forms a high-conductivity two-dimensional (2D) hole gas. Analogous to the ubiquitous 2D electron gas, it is desirable in nitride semiconductors for wide-bandgap p-channel transistors. They report the observation of a polarization-induced high-density 2D hole gas in epitaxially grown gallium nitride on aluminum nitride and show that such hole gases can form without acceptor dopants. The measured high 2D hole gas densities of about  $5 \times 10^{13}$  per square centimeters remain unchanged down to cryogenic temperatures and allow some of the lowest p-type sheet resistances among all wide-bandgap semiconductors.

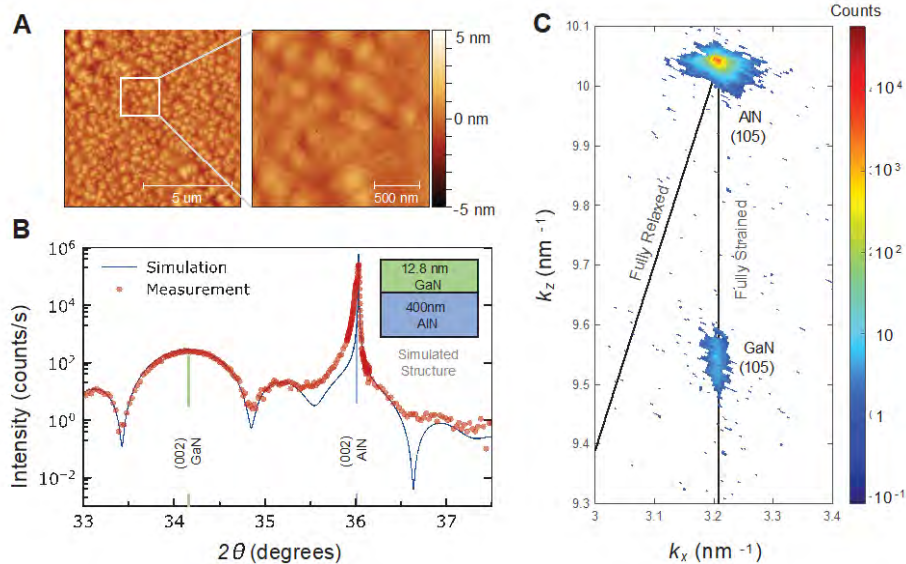

Chaudhuri et al. This work used the Cornell Nanoscale Facility.

This work was supported by Intel, AFOSR FA9550-17-1-0048, NSF (1710298 and 1534303), Cornell CCMR (DMR- 1719875). *Science* 365, 1454–1457 (2019).

*National Research Priority: NSF-Growing Convergence Research (Microelectronics)*

# Real-time Vibrations of a Carbon Nanotube

Lipson, McEuen, and coworkers produced miniature mechanical oscillators. This field is rapidly evolving, with emerging applications including signal processing, biological detection and fundamental tests of quantum mechanics. As the dimensions of a mechanical oscillator shrink to the molecular scale, such as in a carbon nanotube resonator, their vibrations become increasingly coupled and strongly interacting until even weak thermal fluctuations could make the oscillator nonlinear. The mechanics at this scale possesses rich dynamics, unexplored because an efficient way of detecting the motion in real time is lacking. Here they directly measure the thermal vibrations of a carbon nanotube in real time using a high-finesse micrometre-scale silicon nitride optical cavity as a sensitive photonic microscope. These experiments open up the study of nonlinear mechanical systems in the Brownian limit (that is, when a system is driven solely by thermal fluctuations) and present an integrated, sensitive, high-bandwidth nanophotonic interface for carbon nanotube resonators

FFT

—

Barnard et al., Columbia Univ. and Cornell Univ. This work used the Cornell Nanoscale Facility.

This work was supported by NSF 0928552 and DMR-1719875; NSF IGERT (DGE-0654193). *Nature* 566, 90 (2019)

*National Research Priority: NSF-Growing Convergence Research (Photonics)*

# Observation of Strong Polarization Enhancement in Ferroelectric Tunnel Junctions

Schlom and collaborators studied a model system of  $\text{BiFeO}_3/\text{La}_{0.7}\text{Sr}_{0.3}\text{MnO}_3$ , and report observation of a dramatic out-of-plane polarization enhancement that occurs with decreasing film thickness. Ferroelectric heterostructures, with the capability of storing data at ultrahigh densities, could act as the platform for next-generation memories. The development of new device paradigms has been hampered by the long-standing notion of inevitable ferroelectricity suppression under reduced dimensions. Despite recent experimental observation of stable polarized states in ferroelectric ultrathin films, the out-of-plane polarization components in these films are strongly attenuated compared to thicker films, implying a degradation of device performance in electronic miniaturization processes. Our electron microscopy analysis coupled with phase-field simulations reveals a polarization-enhancement mechanism that is dominated by the accumulation of oxygen vacancies at interfacial layers. The results shed light on the interplay between polarization and defects in nanoscale ferroelectrics and suggest a route to enhance functionality in oxide devices.

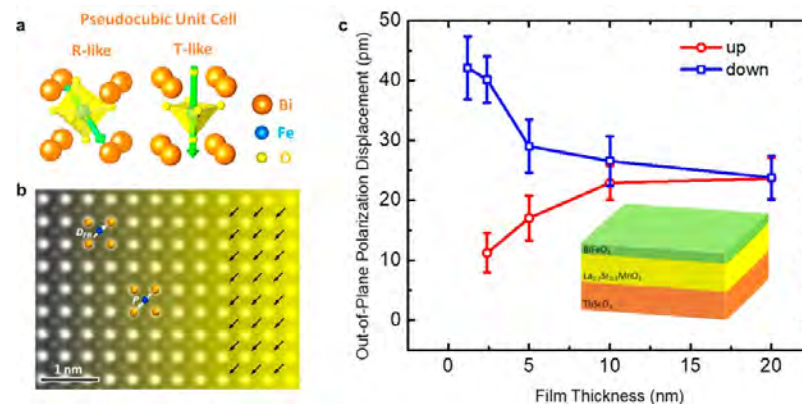

Cohen et al., Cornell Univ., UC Irvine, Penn State and NIST. This work used the Cornell Nanoscale Facility.

This work was supported by : DOE DE-SC0014430, DOE FG0207ER46417, NSF OCI0821527, NSF EEC-1160504. *Nano Lett.* 2020, 20, 4850–4856

*National Research Priority: NSF-Growing Convergence Research (Microelectronics)*

# Capillary Origami with Atomically Thin Membranes

Park, McEuen, Cohen, and coworkers showed that a monolayer of molybdenum disulfide ( $\text{MoS}_2$ ) can be folded into three-dimensional shapes by a technique called capillary origami, in which the surface tension of a droplet drives the folding of a thin sheet. Small-scale optical and mechanical components and machines require control over three-dimensional structure at the microscale. Inspired by the analogy between paper and two-dimensional materials, origami-style folding of atomically thin materials offers a promising approach for making microscale structures from the thinnest possible sheets. We define shape nets by patterning rigid metal panels connected by  $\text{MoS}_2$  hinges, allowing us to fold micron-scale polyhedrons. Finally, we demonstrate that these shapes can be folded in parallel without the use of micropipettes or microfluidics by means of a microemulsion of droplets that dissolves into the bulk solution to drive folding. These results demonstrate controllable folding of the thinnest possible materials using capillary origami and indicate a route forward for design and parallel fabrication of more complex three-dimensional micron-scale structures and machines.

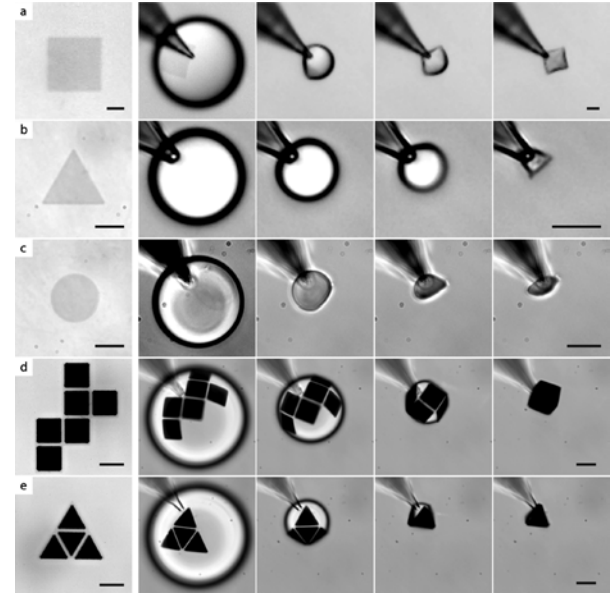

Michael F. Reynolds et al., Univ. of Chicago and Cornell Univ. This work used the Cornell Nanoscale Facility.

This work was supported by Cornell Center for Materials Research (DMR- 1719875), AFOSR (MURI: FA9550-16-1-0031), University of Chicago MRSEC (NSF DMR-1420709); PARADIM - DMR-1539918), NSF GRFP (DGE-1746045). *Nano Letters* 2019 19 (9), 6221-6226

*National Research Priority: NSF-Growing Convergence Research*



# Hybrid Achromatic Metalenses

Recent research within KY Multiscale created optical lenses between 10 and 50 times thinner than a human hair. These metalenses focus light using subwavelength structures fabricated by nanoscale 3D printing. Unlike many metalenses, the novel lenses correct chromatic aberrations to image with light spanning a broad range of wavelengths in the short-wave infrared. The compact size, light weight, and mass manufacturability of metalenses make them ideal for mobile and airborne imaging, as well as for integration with optoelectronic systems for communications, computing, and medical diagnostics.

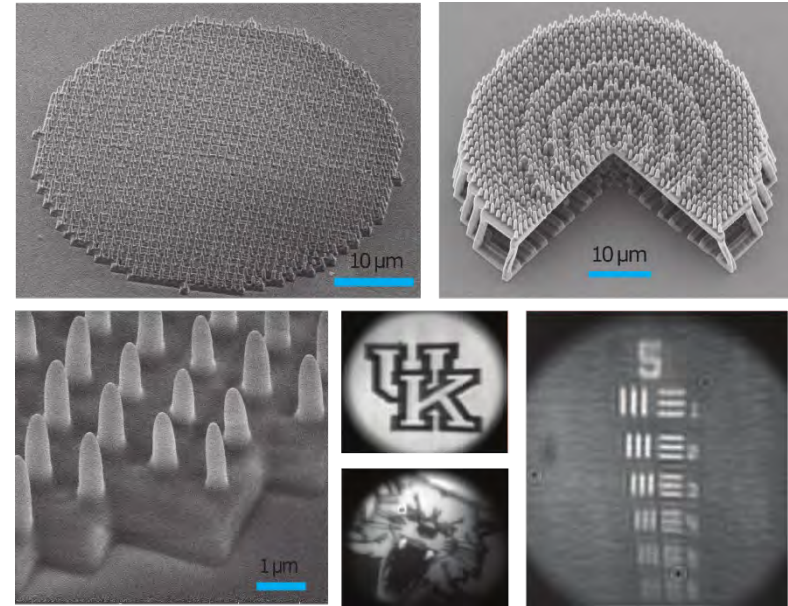

(Upper) Single- and multi- element hybrid achromatic metalenses fabricated using nanoscale 3D printing.  
(Lower) Enlarged view of the metalens structure and broadband infrared images captured using the metalenses.

Fatih Balli, Mansoor Sultan, Sarah Lami, and J. Todd Hastings. Depts. of Electrical and Computer Engineering and Physics and Astronomy, University of Kentucky. Work performed at the U.K. Center for Nanoscale Science and Engineering and the U.K. Electron Microscopy Center.

This research was supported by Intel Corporation and appears in *Nature Communications* 11, 3892 (2020)

*National Research Priority: NSF-Growing Convergence Research*

# Improving Ionic Conductivity of Composite Polymer Electrolytes for Lithium-Ion Batteries

This work focuses on ceramic–polymer composite electrolytes (CPEs) for lithium-ion battery electrodes. Simultaneously achieving both high ionic conductivity and mechanical flexibility has been a longstanding challenge in this area. Here the investigators show that, by incorporating 10 wt.% mixed-sized fillers of  $\text{Li}_7\text{La}_3\text{Zr}_2\text{O}_{12}$  (LLZO) doped with Nb/Al, the room-temperature ionic conductivity of a polyvinylidene fluoride (PVDF)– $\text{LiClO}_4$ -based composite can be an order of magnitude higher than that with nano- or micrometer-sized LLZO particles as fillers. The CPE also shows a high lithium-ion transference, a stable and low Li/CPE interfacial resistance, and good mechanical properties favorable for all-solid-state lithium-ion battery applications.

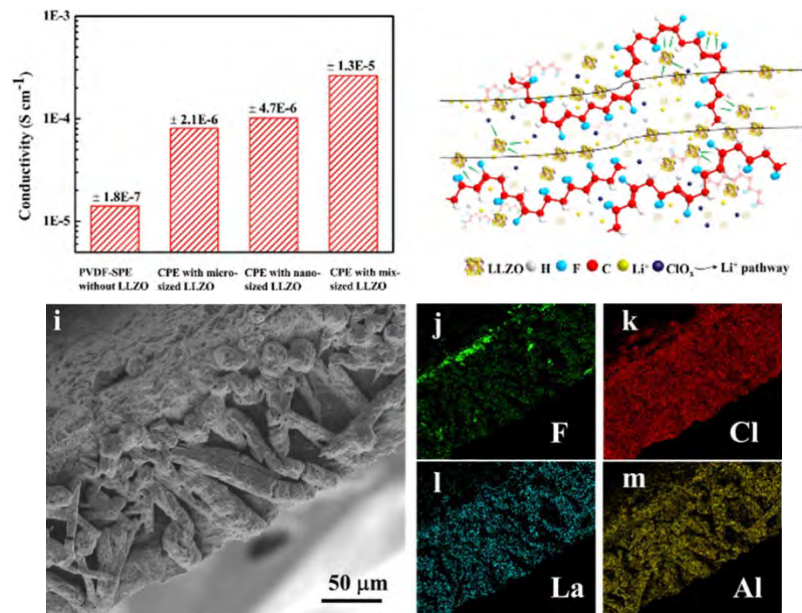

Upper: Ionic conductivities of CPEs with LLZO fillers.  
Lower: Cross-sectional SEM image and EDS mappings of CPE with mixed-sized, Nb/Al-doped, LLZO fillers.

Y. Sun, Y., X. Zhan, J. Hu, Y. Wang, S. Gao, Y. Shen, and Y. T. Cheng, Dept. of Chemical and Materials Engineering, University of Kentucky, and College of Chemistry and Chemical Engineering, Anhui University, Hefei, China. Work performed at the U.K. Electron Microscopy Center.

This research was supported by NSF Award 1355438 and appears in *ACS Appl. Mater. Interfaces* 11, 12467-12475 (2019).

National Research Priority: NSF-Growing Convergence Research

# Fluctuating Superdomains in an Artificial Anti-ferromagnet

This work focused on understanding magnetic fluctuations in patterned arrays of nanomagnets. These structures are referred to as artificial spin lattices (ASLs) and include the widely studied artificial spin ices. ASLs serve as model condensed matter systems and are also being considered for emerging applications in low-power, high-security computing and magneto-optics. The investigators fabricated square ASLs from  $\approx 3$ -nm thick permalloy and studied them using X-ray photoemission electron microscopy and coherent soft X-ray scattering. They found that the nucleation, annihilation, and fluctuation of antiferromagnetic superdomains was key to describing the system's behavior near its antiferromagnetic to paramagnetic transition temperature.

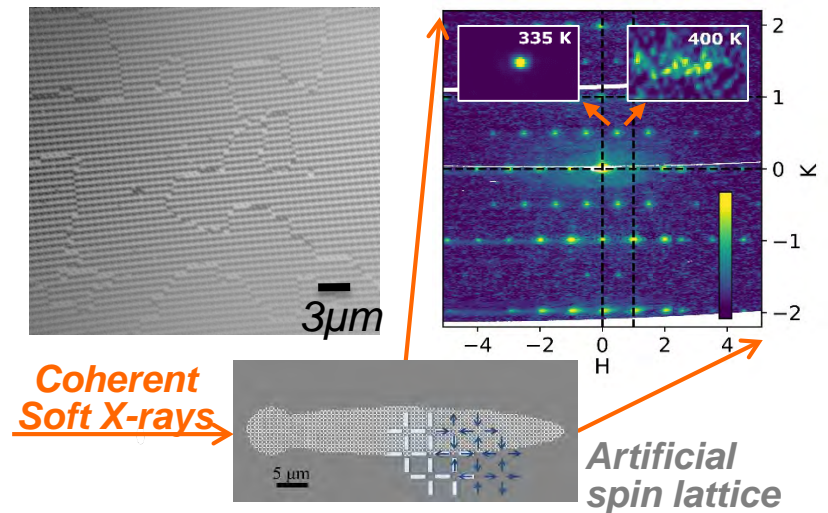

**Upper left:** Antiferromagnetic superdomains (striped regions) in a permalloy artificial spin lattice (XMCD-PEEM).  
**Right and below:** Coherent soft X-ray scattering with XPCS enables the study of superdomain dynamics.  
**Inset:** Speckle patterns near the antiferromagnetic Bragg condition.

X. M. Chen, B. Farmer, J. S. Woods, S. Dhuey, W. Hu, C. Mazzoli, S. B. Wilkins, R. V. Chopdekar, A. Scholl, I. K. Robinson, L. E. De Long, S. Roy, and J. T. Hastings, University of Kentucky, Lawrence Berkeley National Laboratory, Argonne National Laboratory, Brookhaven National Laboratory. Work performed at the U.K. Center for Advanced Materials, Center for Nanoscale Science and Engineering, and Electron Microscopy Center.

This research was supported by DOE BES Award DE-SC0016519. *Physical Review Letters* 123, 197202 (2019)

National Research Priority: NSF-Growing Convergence Research



# Nanoscale Focused Electron Beam Induced Etching of Nickel using a Liquid Reactant

This research introduces a new method for prototyping and repairing nickel nanostructures. Such nanostructures have found widespread application as both functional components and as part of the lithographic pattern transfer process. Electron-beam induced etching of nickel is desirable for the repair and editing of lithographic masks and imprint templates without substrate damage. However, there are no known gas-phase reactants that produce volatile nickel products under e-beam irradiation. Here the investigators demonstrated the successful etching of nickel by a focused electron beam in an environmental scanning electron microscope using a liquid reactant, aqueous sulfuric acid. This approach enables local nickel patterning with complete film removal but without damaging underlying layers.

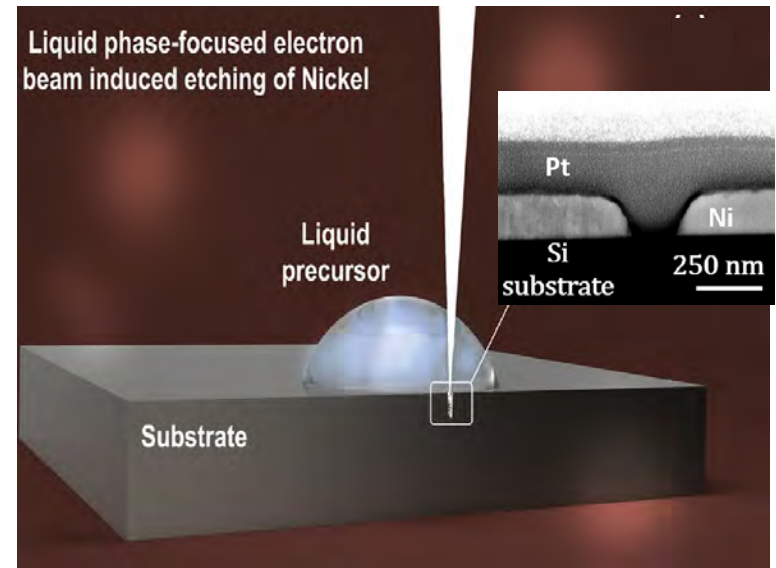

*A focused electron beam penetrates through an aqueous sulfuric acid solution to induce etching of nickel. This technique permits nanoscale etching without damage to underlying materials. **Inset:** Cross-section of hole etched through a 170-nm thick Ni film.*

Sarah K Lami, Amrit P Kaphle, Nicolas J Briot, Aurélien Botman, and J Todd Hastings, Depts. of Electrical and Computer Engineering, Chemical and Materials Engineering, and Physics and Astronomy, University of Kentucky and Thermo Fisher Scientific. Work performed at the U.K. Center for Nanoscale Science and Engineering, Center for Advanced Materials, and Electron Microscopy Center.

This research was supported by NSF Award CMMI 1538650 and appears in *Nanotechnology* 31, 425301 (2020).

*National Research Priority: NSF-Growing Convergence Research*



# Characterizing biochar for use as a filler material in biodegradable polymers

This work looks to examine the chemical, structural and electrical properties of biochar for use as an electrically conductive filler in biodegradable plastics. Past work has shown biochar to be a promising, biodegradable replacement for petroleum-based carbon powders in these biodegradable materials. This work looks to optimize biochar's chemical and structural properties to increase biochar's compatibility as a filler in biodegradable polymers and to correlate biochar processing conditions with increases in conductivity. To this end, Raman spectroscopy is used to identify the disordered and graphitic content of the biochars examined, and to correlate these values with electrical conductivity.

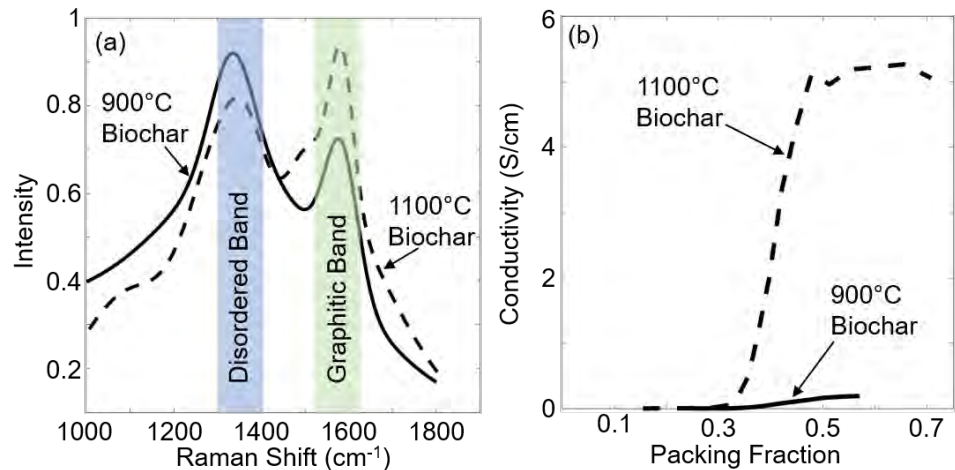

A comparison of the disordered and graphitic Raman bands (a) and biochar conductivity (b) for a biochar produced at 900 ° C and 1100 ° C . An increase in conductivity is seen with an increase in the graphitic band in the 1100 ° C biochar.

Seth Kane and Cecily Ryan, Mechanical and Industrial Engineering Dept., Montana State University. Work performed at MONT facility Center for Biofilm Engineering.

This work was supported by the Environmental Research and Education Foundation, the Hawthorne Foundation and Montana State University.

National Research Priority: NSF-Growing Convergence Research

# 3D Printing on Glass for Direct Sensor Integration

This work demonstrated a straightforward procedure for integrating glass substrate sensing platforms with 3D printed fluidic channels. Gold micro-interdigitated electrodes (30  $\mu\text{m}$  electrode width and spacing) were fabricated on glass substrates and then treated with a bind-silane to allow a channel (~50  $\mu\text{l}$ ) to be 3D printed on the sensor. The glass substrate forms the base of the channel allowing for ideal optical access and interaction with sensing elements. Electrical conductivity, Raman, and impedance spectra measurements showed the sensing surface and performance was unaffected by the printing process. To show the viability of the system, impedance spectra of *E.coli* K12 suspended in milli-Q water were recorded and it was found the sensor could distinguish down to  $10^6$  CFU/ml. In addition, KCl conductivity solutions were used to compare conductivity measurements between the sensor and a commercial conductivity probe. The packaged sensor and the conductivity probe differed less than 8% in the designed sensor range of 30-300  $\mu\text{S/cm}$ .

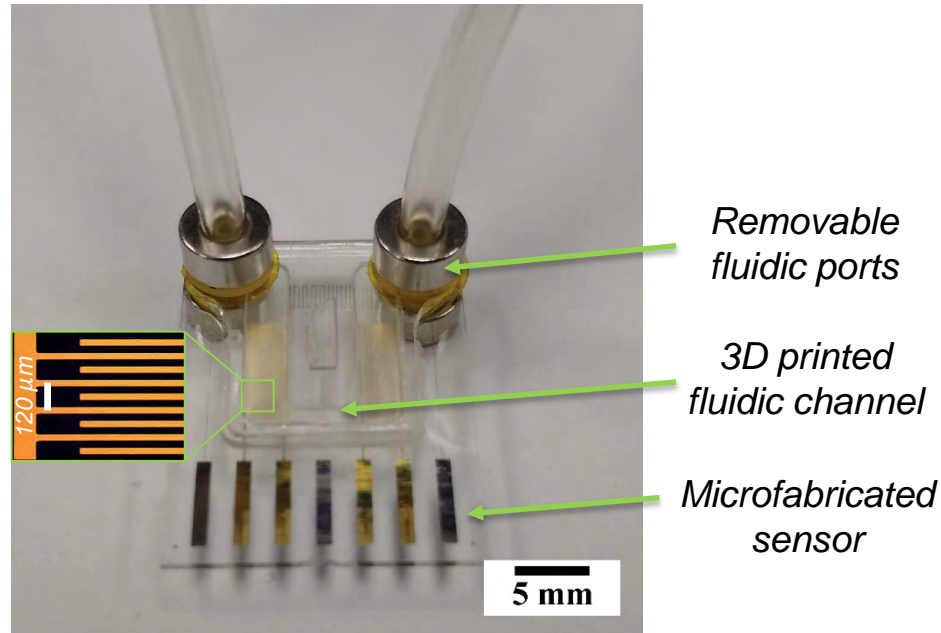

*A 3D printed fluidic microchannel on a microfabricated electrochemical impedance sensor. The channel is printed so that the sensing elements on the glass substrate are in direct contact with the fluid.*

Michael Neubauer, Matt McGlennen, Sawyer Thomas, and Stephan Warnat, Montana State University. Work performed at MONT facility Montana Microfabrication Facility.

This work was supported by Dr. Warnat's MSU startup package and the NNCI. DOI: 10.1088/2631-8695/ab5e9f

*National Research Priority: NSF-Growing Convergence Research*

# The effect of submicron grain size on thermal stability and mechanical properties of high-entropy carbide ceramics

Wang and coworkers at UNL used NNF facilities and fabricated  $(\text{Hf}_{0.2}\text{Zr}_{0.2}\text{Ta}_{0.2}\text{Nb}_{0.2}\text{Ti}_{0.2})\text{C}$  high-entropy ceramics (HEC) with a submicron grain size of 400 to 600 nm by spark plasma sintering using a two-step sintering process. Both X-ray and neutron diffractions confirmed the formation of single-phase with rock salt structure in the as-fabricated  $(\text{Hf}_{0.2}\text{Zr}_{0.2}\text{Ta}_{0.2}\text{Nb}_{0.2}\text{Ti}_{0.2})\text{C}$  samples. The effect of submicron grain size on the thermal stability and mechanical properties of HEC was investigated. Compared to the coarse-grain HEC with a grain size of 16.5  $\mu\text{m}$ , the bending strength and fracture toughness of fine-grained HEC were 25% and 20% higher respectively. The improvement of mechanical properties in fine-grained HEC may be attributed to micromechanistic mechanisms such as crack deflection. These findings provide important guidance on the development of high-performance ceramic materials with submicron grain sizes using the novel high-entropy strategy.

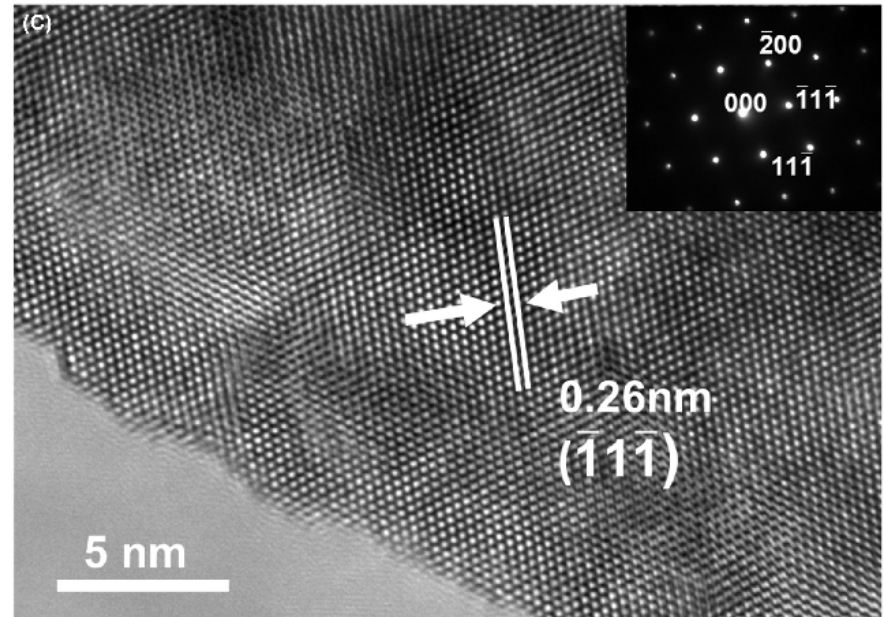

HRTEM image of the fine-grained F-1  $(\text{Hf}_{0.2}\text{Zr}_{0.2}\text{Ta}_{0.2}\text{Nb}_{0.2}\text{Ti}_{0.2})\text{C}$ . Insert: selected area electron diffraction pattern

Fei Wang Xiang Zhang, Xueliang Yan, Yongfeng Lu, Michael Nastasi, Yan Chen, Bai Cui, Univ. of Nebraska-Lincoln.  
Work performed in part at the Nebraska Nanoscale Facility.

*Jour. of Amer. Ceramic Society* 103, 4463, 2020

National Research Priority: NSF-Growing Convergence Research



# SiOC functionalization of MoS<sub>2</sub> as a means to improve stability as sodium-ion battery anode

The development of feasible, scalable, and environmentally-safe electrode materials that provide stable cycling performance are critical for success of beyond lithium rechargeable batteries and supercapacitors. With respect to the sodium-ion battery (SIB) anodes constituting of transition metal dichalcogenides such as molybdenum disulfide (MoS<sub>2</sub>), poor cycle stability and fast capacity degradation, due to low electronic conductivity and dissolution of chemical species in the electrolyte, hinders use of these promising layered materials as SIB anodes. Soares and coworker from Kansas State University report chemical functionalization in MoS<sub>2</sub> nanosheets with polymer-derived silicon oxycarbide or SiOC with the aim to preserve MoS<sub>2</sub> from dissolution in the SIB organic electrolyte, without compromising its role in sodiation and desodiation processes. Their results suggest that a MoS<sub>2</sub>-SiOC composite electrode is effective in bringing improved cycle stability to sodium-ion cycling over neat MoS<sub>2</sub> even after 100 cycles. MoS<sub>2</sub> with precursor-derived ceramics presents facile and safe preparation; therefore, enabling potential for application as SIB anode. In this work, NNF external user Soares used NNF facilities to characterize the electrode materials.

Davi Marcelo Soares and Gurpreet Singh, Kansas State University. Work performed in part at the Nebraska Nanoscale Facility.

The work was supported by NSF (CMMI NSF CAREER Award) grant no. 1454151. *Nanotechnology* 31, 145403, 2020

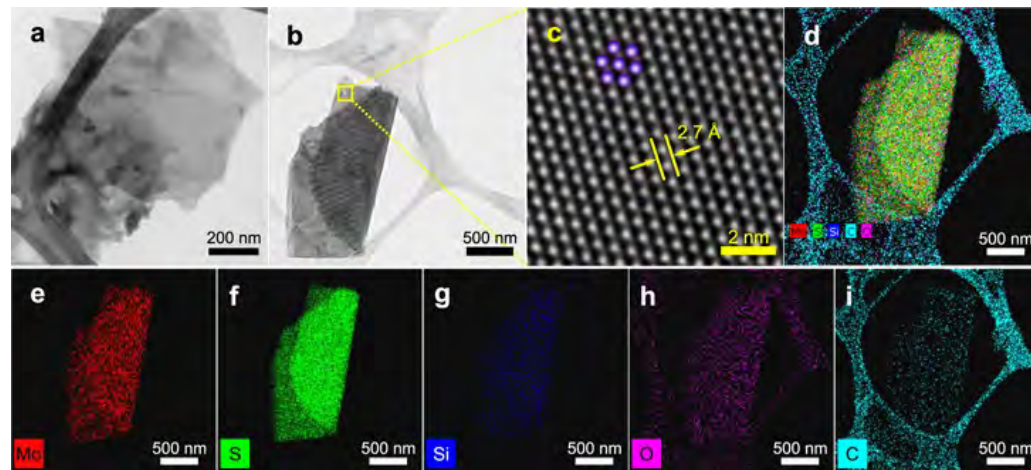
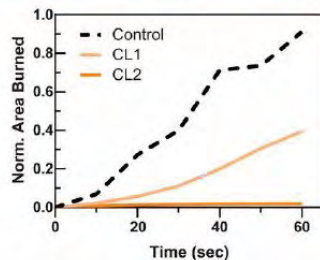
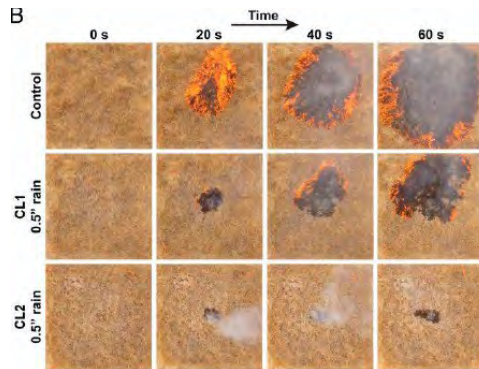

**Figure 2.** (a) TEM image of MoS<sub>2</sub>-SiOC composite, (b) HRTEM image of MoS<sub>2</sub>-SiOC composite sheet, (c) annular dark-field STEM, (d) STEM images with elemental mapping of, (e) Mo, (f) S, (g) Si, (h) O, and (i) C.

*National Research Priority: NSF-Growing Convergence Research*



# Wildfire prevention through prophylactic treatment of high-risk landscapes using viscoelastic retardant fluids



**Above:** Controlled burn of unmowed grass either untreated, or treated with 2 different levels of retardant.

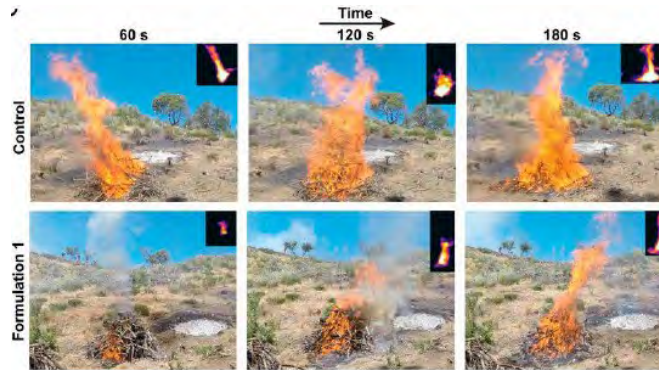

**Above:** Pilot-scale burns of chamise piles, treated or untreated, with infrared (IR) image overlays.



Technology licensed to the startup Ladera Tech: <https://www.ladera.tech/>

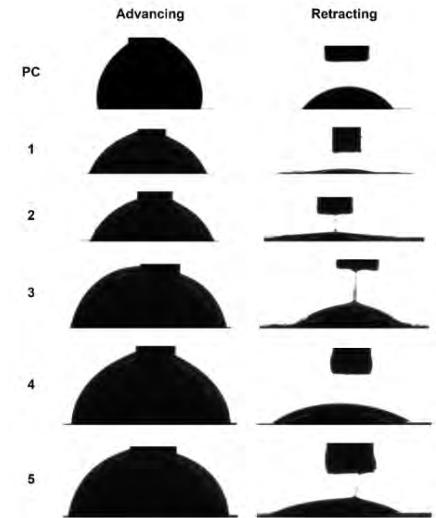

**Above:** Contact angle goniometer measurements (nano@stanford) of droplet spreading. Each polymer formulation showed better wetting than the Phos-Check (PC) control.

Eric A. Apple, Craig S Criddle (Stanford University) and Jesse D. Acosta (California Polytechnic State University, San Luis Obispo). Work performed at Stanford Nano Shared Facilities, nano@stanford site.

This work was supported by NSF Award # ECCS-1542152. PNAS (2019) doi:10.1073/pnas.1907855116

National Research Priority: NSF-Growing Convergence Research

# Rapid diagnostics with slow light using silicon photonics

Silicon nanoantennas confine light and amplify the local electric field, resulting in ultra-high sensitivity for rapid, accurate diagnostics

The precise asymmetry of the nanoantennas “slows” transmitted light, resulting in sharp resonances

When the silicon is functionalized to bind with specific nucleic acids or antibodies (e.g. for SARS-CoV-2 diagnostics), the sharp resonance shifts

In the future, isolated antennas can be functionalized separately for highly multiplexed diagnostics on a scalable silicon-based platform

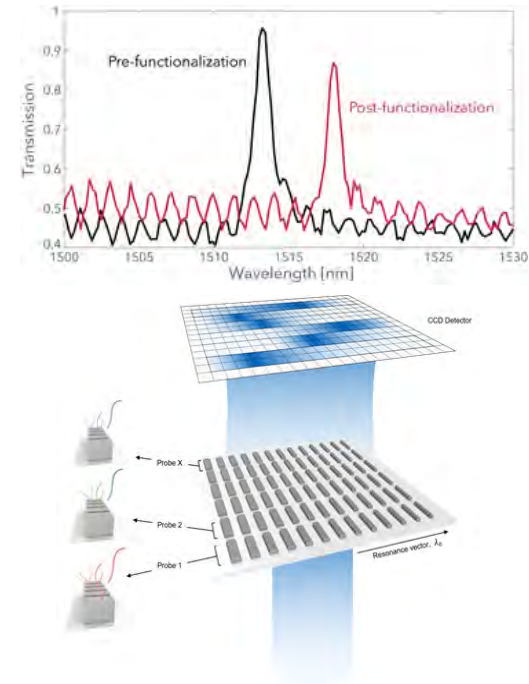
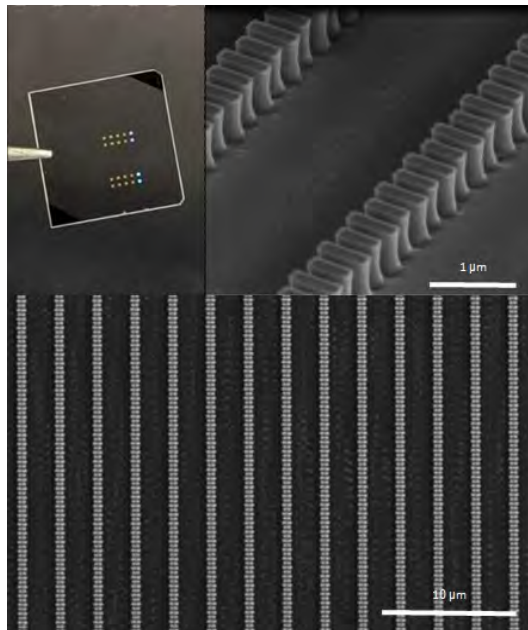

Jennifer A. Dionne, Materials Science and Engineering Department, Stanford University. Work performed at Stanford Nano Shared Facilities, nano@stanford site.

This work was supported by NSF Award # ECCS-1542152. Work in progress and *Nat. Nano* 2020 (doi: 10.1038/s41565-020-0754-x)

National Research Priority: NSF-Growing Convergence Research

# MEMS-actuated Metasurface Alvarez Lens

We have developed a miniature lens which can change focal length quickly at low power. The device is based on the Alvarez lens design in which the relative lateral movement of two optical elements changes the optical power. A typical Alvarez lens uses optics with matching curved surfaces. In this work, we converted the design to metasurface optics, which provide the same effect as refractive lens elements but are flat and thin, making it easier to incorporate them in miniature devices. Our team used a MEMS system to move the metasurface elements, enabling them to achieve a 1460-diopter change with a voltage application under 20V. This approach will be useful in fabricating tunable lenses for ultra-compact applications, such as endoscopy and mobile devices.

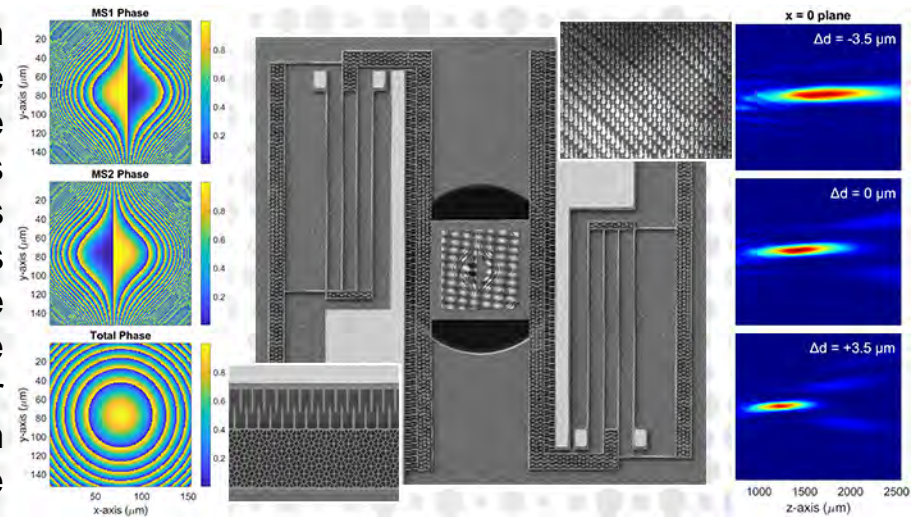

*Left: Simulated quadratic phase of two overlaid Alvarez metasurfaces with cubic phase profiles.  
Center: SEM images of MEMS-actuated Alvarez metalens.  
Right: Simulated change in focal location for Alvarez metasurfaces with varying lateral displacements.*

Zheyi Han, Shane Colburn, Arka Majumdar, Karl F. Böhringer, Electrical & Computer Engineering, Institute for Nano-engineered Systems, Physics, and Bioengineering, University of Washington. Work performed in part at the Washington Nanofabrication Facility.

This work was supported in part by NSF NNCI-1542101, ECCS-1337840, 2040527, and Tunoptix Inc. *Microsystems & Nanoengineering* (2020) 6:79.

*National Research Priority: NSF-Growing Convergence Research*



# Nanomechanical Property Characterization of Composite Adhesive Co-bond Systems

This research is directed toward further understanding how manufacturing methods affect initial bondline formation between Carbon Fiber Reinforce Plastic (CFRP) substrates and epoxy adhesives. Nanoindentation techniques were used to characterize the mechanical response of adhesively bonded carbon fiber epoxy samples including the matrix resin, adhesive, and bondline mixing zone (interface/interphase). A co-bond bondline was characterized to understand the differences in interface and/or interphase development because co-bonds produce a mixing of the matrix resin and the adhesive, resulting in a mixed interface, or interphase region. By measuring mechanical responses on the micron scale, the data identifies various structures and regions, such as where the adhesive/adherend interphase begins, and if it is heterogeneous or homogeneous in nature. This work is unique in that other mechanical property characterization methods have not been able to isolate the adhesive/adherend interphase due to the micron scale of this region. These methods not only measure the adhesive/adherend interphase thickness but also allow for the evaluation of properties that may be related to bond quality and performance.

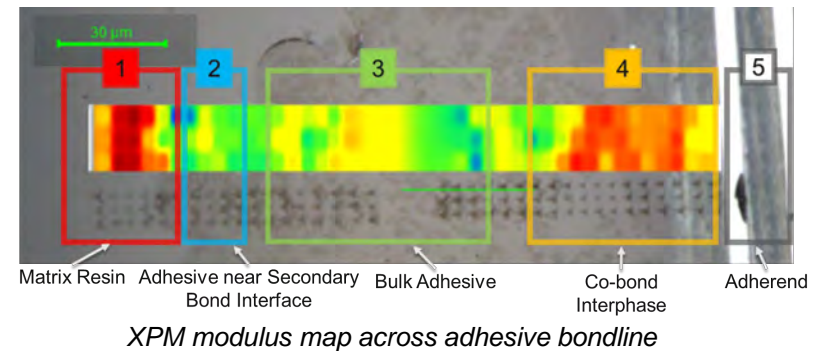
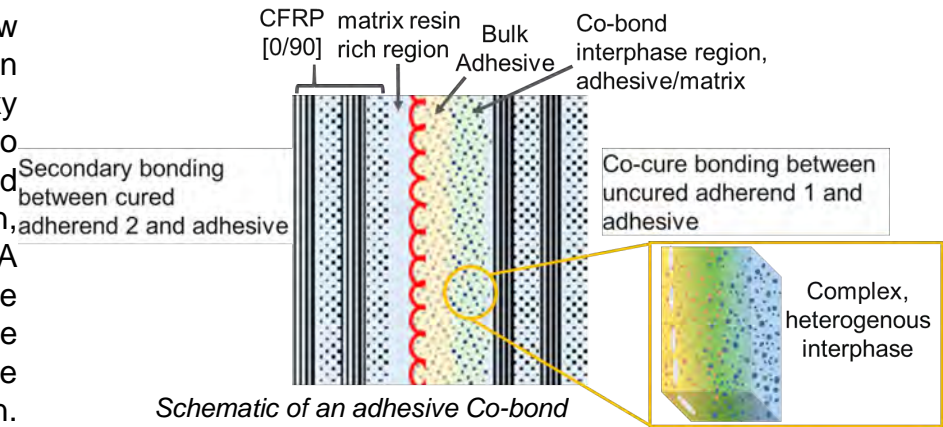

Rita Olander, Ashley Tracey, Brian Flinn, University of Washington Material Science & Engineering, Boeing Company. Part of this work was conducted at the Washington Nanofabrication Facility/Molecular Analysis Facility.

This work was supported by the FAA and The Boeing Company through the FAA Center of Excellence at the University of Washington (Advanced Materials in Transport Aircraft Structures).

National Research Priority: NSF-Growing Convergence Research



# Amorphization Mechanism of SrIrO<sub>3</sub> Catalyst

To understand why SrIrO<sub>3</sub> exhibits record-high catalytic activity (~1000 times better than the best commercial standard IrO<sub>2</sub>) in oxygen evolution reaction for water-splitting, Oregon State University teamed with Argonne National Laboratory and Cornell University to perform a systematic surface study on SrIrO<sub>3</sub> thin film model catalyst system using both synchrotron-based and lab-based NNI facilities. We found that the surface amorphization of SrIrO<sub>3</sub> leads to Sr-deficient octahedra, which is the key to enable the high performance of the electrocatalysts. Density function theory provides further atomic insights on the surface structural transformation. Our results provide mechanistic information to understand the structure-property relationship of high-performance catalysts and can be useful for future materials design.

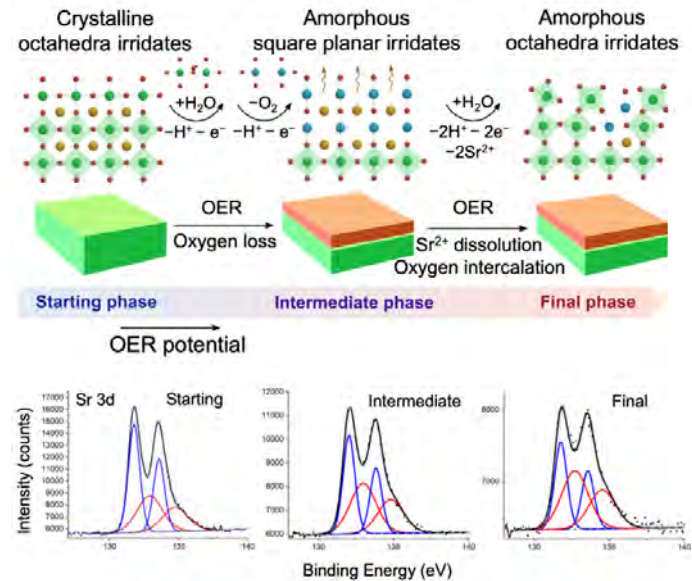

Top: DFT calculation for the atomic scale change of SrIrO<sub>3</sub> catalyst  
Center: Schematic illustration of the surface amorphization changes during oxygen evolution reaction for water-splitting.  
Bottom: XPS spectra (NNCI facility) show the composition changes.

G. Wan, J. W. Freeland, J. Kloppenburg, G. Petretto, J. N. Nelson, D.-Y. Kuo, C.-J. Sun, J. Wen, J. T. Diulus, G. S. Herman, Y. Dong, R. Kou, J. Sun, S. Chen, K. Shen, D. Schlom, G.-M. Rignanese, G. Hautier, D. D. Fong, Z. Feng, H. Zhou, J. Suntivich, Argonne National Laboratory, Université Catholique de Louvain, Cornell University, Oregon State University, University of Houston. Work performed in part at the Oregon Nanofabrication Facility.

This work was supported in part by NSF NNCI-1542101 and Oregon State University. *Science Advances* (2021) 7:eabc7323.

National Research Priority: NSF-Growing Convergence Research

# Characterization of Aircraft Exhaust Particles to Identify Potential Health Hazards

Piston powered aircraft burning leaded gasoline contribute ~70% of lead in US atmosphere

First EM visualization of exhaust particles emitted from a piston powered aircraft in flight burning leaded fuel

TEM enabled analysis of exhaust particle size and composition

Typically single 4 nm lead dibromide microcrystal beads embedded in a matrix of burned hydrocarbons

Toxicity of these lead-based particles must be further investigated to understand potential impacts on human health

Jack Griffith, Lineberger Comprehensive Cancer Center, Departments of Microbiology and Immunology and Biochemistry and Biophysics, University of North Carolina at Chapel Hill. Work performed at the Chapel Hill Analytical and Nanofabrication Laboratory.

Work supported by NIEHS (R56 E031773). *Atmos. Pollut. Res.*, (2020).

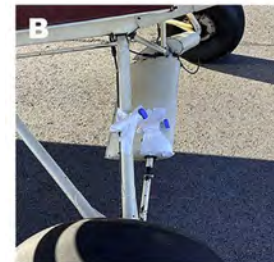

*Exhaust samples were trapped on EM supports after exiting the aircraft exhaust pipe*

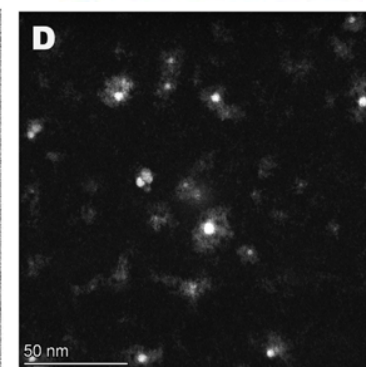
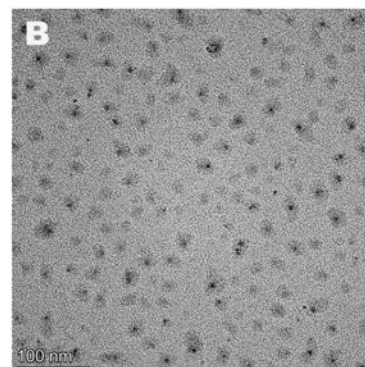
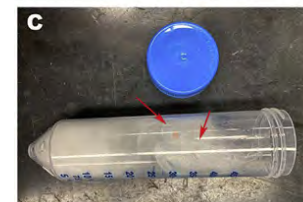

*TEM and HAADF imaging of exhaust particles containing lead di-bromide. TEM image (left) and HAADF dark field image (right) of exhaust particles*

*National Research Priority: NSF-Growing Convergence Research*

# Symmetry-Breaking-Induced Plasmonic Exceptional Points and Nanoscale Sensing

## Scientific and engineering significance:

*Symmetry breaking* plays a fundamental role in many physical phenomena and sensing to our observation of the Universe via physical quantities such as mass, time or distance. In the nutshell, the research demonstrates symmetry breaking in photonics system, namely *exceptional point (EP) with simultaneous coalescence of the resonances and loss rates*. With plasmonics, the optical wavelengths are shrunk to electronic and molecular length scales, enabling unprecedented sensitivity for molecular sensing. The work opens the way to a new class of nanoscale devices, sensors and imagers based on *topological polaritonic effects*.

*Courtesy of Prof. Boubacar Kanté (UC Berkeley)*

*A bilayer periodic plasmonic structure for demonstration of exceptional points (EPs).*



*An EP singularity (green dot) occurs at ~241 THz*

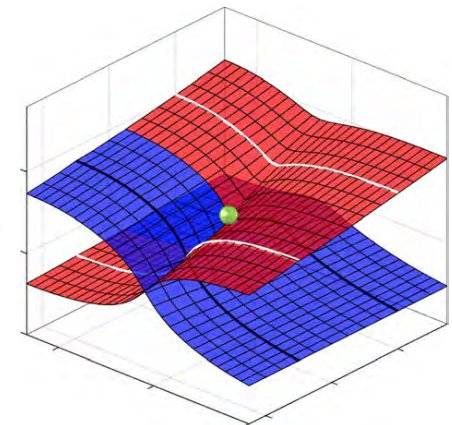

Jun-Hee Park, Abdoulaye Ndao, Wei Cai, Liyi Hsu, Ashok Kodigala, Thomas Lepetit, Yu-Hwa Lo and Boubacar Kanté,

This work was supported by NSF ECCS-1542148, NSF Career Award (ECCS-1554021), ONR Young Investigator Award (N00014-17-1-2671), ONR JTO MRI Award (N00014-17-1-2442), and US DOE (DE-EE0007341). *Nature Physics*, 16, 462-468, April 2020.

*National Research Priority: NSF-Convergence Research and NSF-Quantum Leap*



# Light Guiding in Atomically Thin Semiconductor

## Scientific and engineering significance:

It was theoretically predicted that the ultimate limit of visible photon guiding can be achieved in *monolayer-thick transition metal dichalcogenides*. The research represents the first experimental demonstration of light guiding in an *atomically thick tungsten disulfide membrane* patterned as a photonic crystal structure. Two-dimensional  $WS_2$  excitonic photoluminescence couples into quasi-guided photonic crystal modes known as resonant-type Wood's anomalies. These modes propagate via total internal reflection with only a small portion of the light diffracted to the far field. Such light guiding miniaturizes optoelectronic devices and tests fundamental physical concepts.

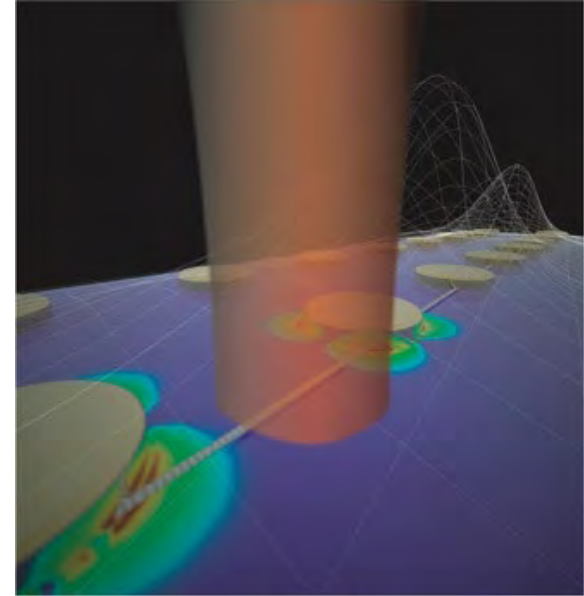

*Visible light guiding was demonstrated in a three-atoms thick waveguide with suspended  $WS_2$ .*

Zhang, Xingwang; De-Eknamkul, Chawina; Gu, Jie; Boehmke, Alexandra L.; Menon, Vinod M.; Khurgin, Jacob; Cubukcu, Ertugrul.

This work was supported by NSF 2-DARE Program (EFMA-1542879 and EFMA-1542863) and DMR-1709996. *Nature Nanotechnol.* 2019, 14(9), 844–850.

*National Research Priority: NSF-Convergence Research*



# Nanoscale structure and growth of enamel elucidated

The Diekwisch lab in the Center for Craniofacial Research and Diagnosis at Texas A&M University College of Dentistry collaborated with **NUANCE** staff on the use of cryo-SEM to understand enamel crystal nucleation and growth at a nanoscale level with minimal sample preparation artifacts. Cryo-fracture micrographs revealed reticular networks of an organic matrix on the surface of elongating enamel crystal ribbons, suggesting that protein coats facilitate c-axis apatite crystal growth.

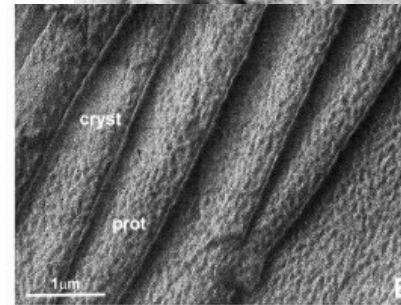
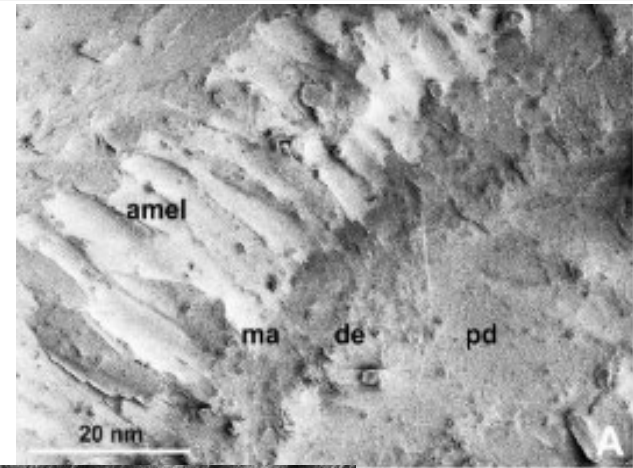

*Cryo-SEM images showing the interface between ameloblasts, protein matrix, dentin and predentin (top) and the organic matrix and enamel crystals (bottom). (ACS Nano 2019)*

Jokisaari and Diekwisch<sup>†</sup>, Bleher<sup>\*</sup>, Qiao<sup>‡</sup>, <sup>†</sup>Physics and Oral Biology, UIC, <sup>\*</sup>NUANCE Center and MSE, Northwestern University, <sup>‡</sup>Condensed Matter Physics and Materials Science, Brookhaven National Laboratory. Work was performed in the **BioCryo facility at NUANCE Center of SHyNE**.

This work was supported by NSF ECCS-1542205, National Institute for Dental and Craniofacial Grant No.DE01890. *ACS Nano* 2019.

*National Research Priority: NSF-Growing Convergence Research*

# Analysis of El Greco Painting: The Assumption of the Virgin

The sample pictured is a cross-section from an area of purple-colored paint in the robe of one of the figures that appeared dark and discolored. The large, irregular particles are smalt, a pigment made from blue-colored glass that was popular in El Greco's time. The EDS maps show that the particles are rich in silicon (characteristic of glass) and depleted in potassium, which is sometimes observed in degraded smalt in which elements such as potassium have leached out of the pigment and into the paint matrix. This finding helps us to understand the intended appearance of this part of the painting.

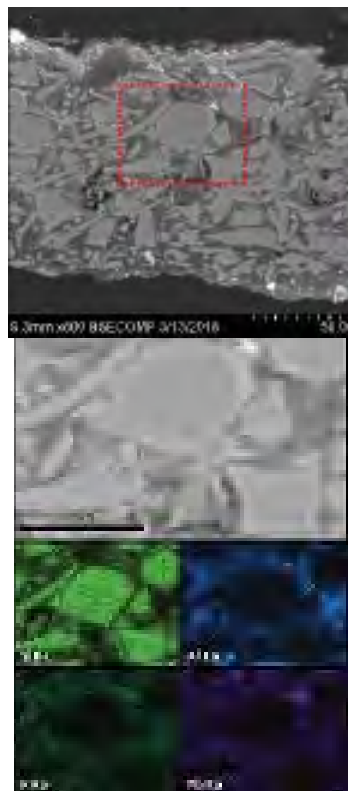

*El Greco "Assumption of a Virgin" painting with backscatter electron image and EDS maps of paint to determine pigment sources.*

Kenneth Sutherland, Art Institute of Chicago. This work was performed in NUANCE Center at Northwestern University of SHyNE.

This work was supported by NSF ECCS-1542205 and through NU-ACCESS by Andrew W. Mellon Foundation.

*National Research Priority: NSF-Growing Convergence Research*

# Nano Sensor Array for Methyl Salicylate Detection in Gaseous Form

This work targets a CNT-FET platform for the detection of Methyl Salicylate (MeSa) in the gaseous phase. Similar to the mammalian olfactory system, the MeSa molecules will be attached to a modified surface of the CNT channel and create a semi-specific recognition by changing the electrical current within it.

Each chip contain multiple separate sensors, that are modified by a different chemical recognition agent. The kinetics of coupling and decoupling of the target molecule and surface modification changes the current in a characteristic manner. Measuring the ratio between them gives an easy to analyze finger print. Cross referencing this ratios with several different modifications will allow accurate detection. The signal amplitude will give the information about the concentration of the analyte.

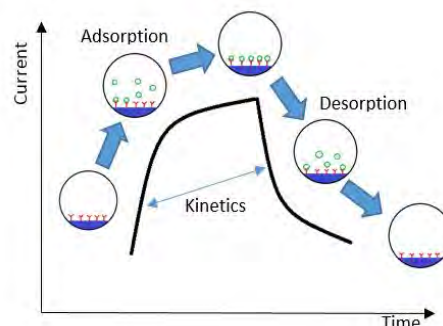

*Sensing principle.*

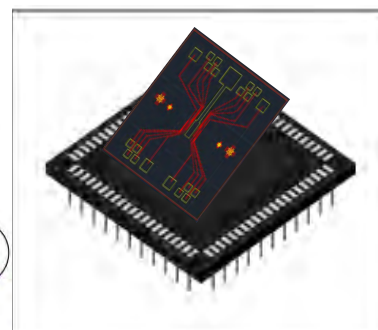

*The Nano-sensor array design on a PCB.*

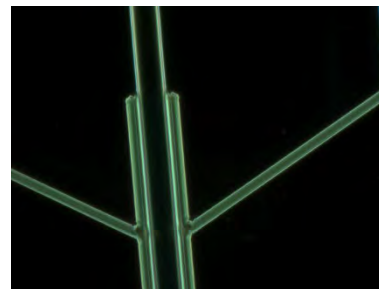

*Light microscope images at X500 magnification in DF (left) and (BF) right.*

Or Zolti and Ramaraja Ramasamy, School of Chemical, Materials and Biomedical Engineering, University of Georgia. Fabrication performed at Georgia Tech's Institute for Electronics and Nanotechnology.

*National Research Priority: NSF-Growing Convergence Research*



# Role of Mineralogy in Controlling Fracture Formation

The overall goal of this work is to enhance understanding of reactive fracture evolution in the context of enhanced oil recovery from low permeability formations. Towards this, this work aims to evaluate the role of mineralogy in controlling fracture formation in shales. Shale samples from the Marcellus formation were fractured using unconfined compression. Scanning electron microscopy BSE and EDS images were then collected of fracture surfaces. Images were processed to infer the mineral composition of the fracture surface. Images were additionally collected of the matrix, processed to identify minerals, and compared with those collected of fracture surfaces.

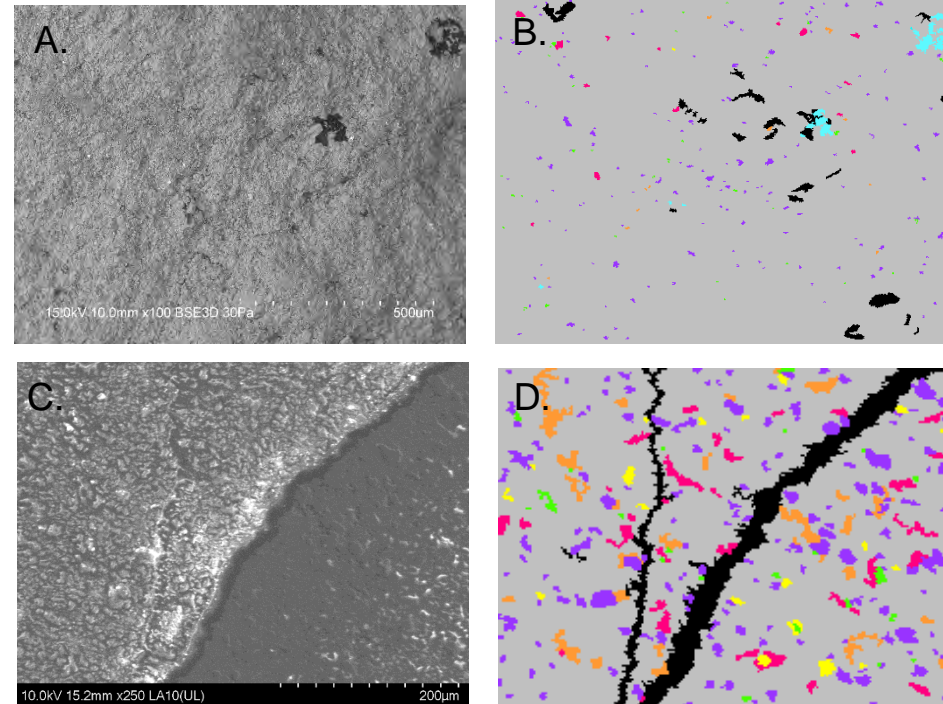

SEM images (A, C) and processed images (B, D) of fracture surface (A, B) and formation matrix (C, D) for a Marcellus shale.

Olivia Brunhoeber and Lauren Beckingham. Department of Civil Engineering, Auburn University, Auburn, AL. Work performed at Georgia Tech's Institute for Electronics and Nanotechnology.

Funding support from the American Chemical Society Petroleum Research Fund.

*National Research Priority: NSF-Growing Convergence Research*



# Fischer-Tropsch studies in 3D-printed stainless steel microchannel microreactor

In this work, 3D printed stainless steel microreactors was successfully used to study the effect of bimetallic M- Co-MCM-41 catalysts in FT synthesis at 1 atm. These catalysts were synthesized using one-pot hydrothermal procedure and resulted in high surface area MCM-41 matrix with an ordered mesoporous structure as-corroborated by low angle XRD and BET surface area studies. TEM and SEM-EDX results indicate a clear hexagonal matrix having porous surface morphology with uniform metal ion distribution. The highest CO conversion for CoFe-MCM-41 (65.5%), Co-MCM-41 (64%) and CoNiMCM-41 (72 %) was obtained at 210C, 240C and 240C respectively. The results from our experiments suggests that the addition of transition metals-Fe, Ni and Ru to Co-MCM-41 can play a vital role in FT synthesis

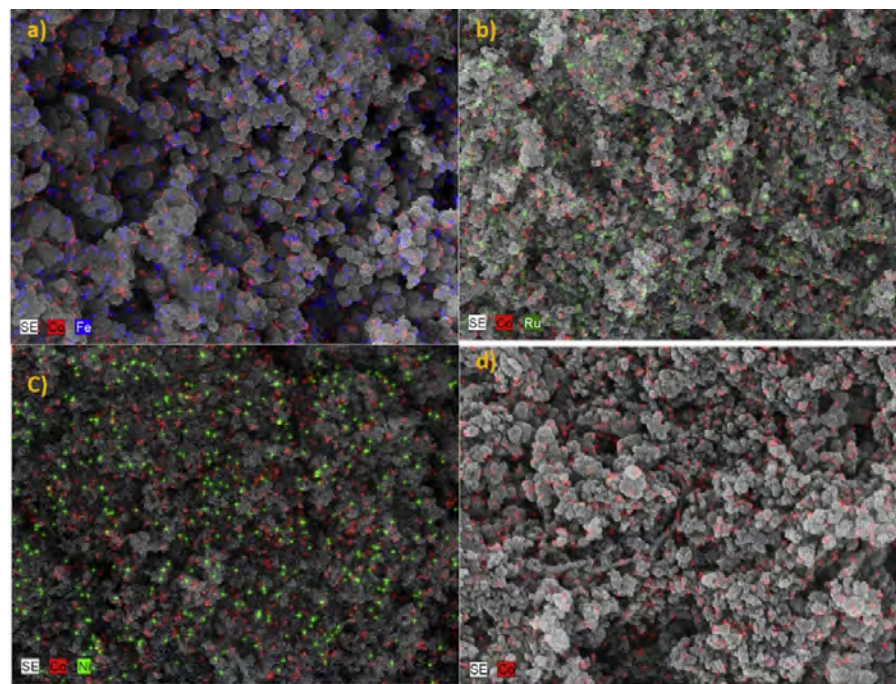

SEM-EDX images of different catalyst samples: a) CoFe-MCM-41 b) CoRu-MCM-41 c) CoNi-MCM-41 d) Co-MCM-41.

Mohammad, Kuila et al., North Carolina A&T State University. Characterization work performed at Joint School of Nanoscience and Nanoengineering.

This work was supported by NSF-CREST Award #260326. *Catalysis Today*, 358(1), 303, 2020.

*National Research Priority: NSF-Growing Convergence Research*

# Collaborative Industry Research with Natural Immunogenics Corporation

Natural Immunogenics manufactures high-quality silver colloids for health applications. Natural Immunogenics' colloidal silver products are thought to contain some of the smallest silver nanoparticles available (1-4 nm in diameter). The company is also looking beyond silver to develop new products based on copper and gold colloids. This collaborative research project aims to comprehensively characterize NIC's colloidal products utilizing experimental methods including but not limited to TEM-EDS, XPS, DLS, FTIR, UV-Vis, and SEM. These analytical tools are used to assess crystal structure, composition, and possible alloying and/or oxidation, resulting in core-shell heterogeneity in support of new product development and manufacturing quality control.

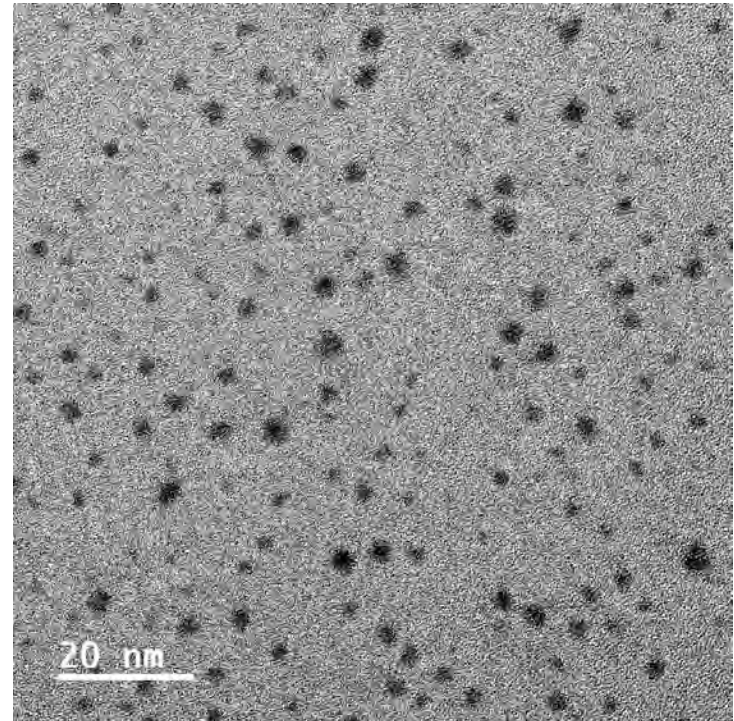

*TEM micrograph of silver nano-colloids.*

N. Qin, A. DaSilva, A. Agustin, and E. Cantando. Work performed at Virginia Tech National Center for Earth and Environmental Nanotechnology (NanoEarth).

This work was supported by NSF Award # ECCS-1542100 and 2025151.

*National Research Priority: NSF-Growing Convergence*



# Detecting Titanium Oxide Engineered Nanoparticles in Urban Water Runoff

Efforts to quantify the release of anthropogenic engineered  $\text{TiO}_2$  nanoparticles into the environment have been hampered by the inability to distinguish natural from engineered nanoparticles. This research proposes to use the Nb to Ti ratios associated with naturally occurring  $\text{TiO}_2$  to isolate the fractions of natural and engineered nanoparticles collected. The water sampled from Ballona Creek, CA was filtered and size fractionated prior to ICP-MS and further analyzed with HRTEM and STEM / EDS mapping to determine particle morphology. The  $\text{TiO}_2$  particles were generally observed to range in size from 50-150 nm.  $\text{TiO}_2$  is the most abundant engineered nanomaterial produced globally.

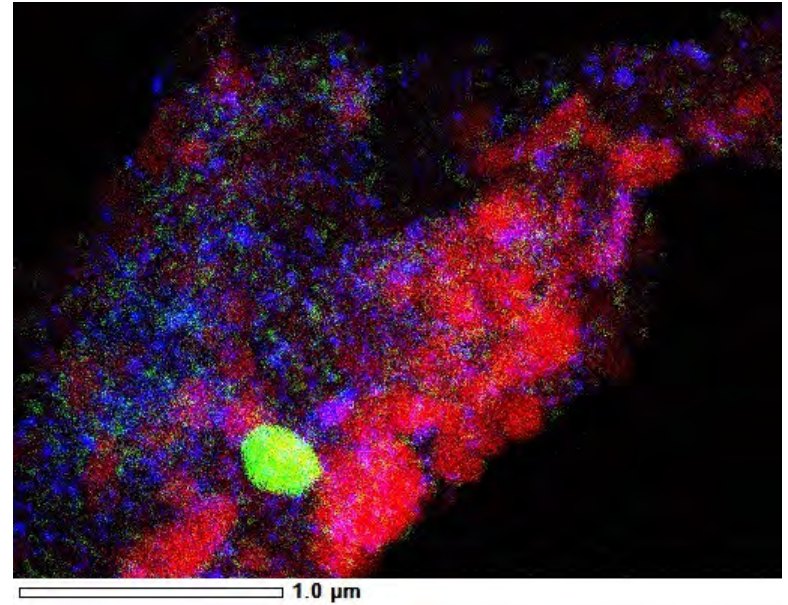

STEM / EDS mapping of pollutants sampled from Ballona Creek, CA with maps of Ti (green), Zn (blue), & O (red).

Baalousha, M., J. Wang, M. Nabi, F. Loosli, R. Valenca, S. K. Mohanty, N. Afrooz, E. Cantando and N. Aich. Work performed at Virginia Tech National Center for Earth and Environmental Nanotechnology Infrastructure (NanoEarth).

This work was supported by NSF Award # ECCS-1542100. *Journal of Hazardous Materials* 392: 122335.

National Research Priority: NSF-Growing Convergence

# Inward & Outward Effectiveness of Cloth Masks, A Surgical Mask, & a Face Shield

The *New York Times* described NanoEarth's Deputy Director Linsey Marr as "one of the world's leading experts on airborne transmission of viruses" and has relied on her heavily for their coverage of the COVID-19 pandemic. In addition to performing research on the efficacy of homemade masks, she has been a key public-health figure in the fight against COVID-19 for numerous media outlets and has been active on Twitter (@linseymarr) to keep the public informed. She excels at taking complicated scientific concepts and describing them in a way that the general public understands. For example, to help people visualize the aerosols we generate by breathing, she compares them to cigarette smoke and when asked about indoor versus outdoor air, she developed an analogy of putting a drop of dye into a glass of water (indoors) versus into the ocean (outdoors).

Jin Pan, Charbel Harb, Weinan Leng, and Linsey C. Marr, Civil and Environmental Engineering, Virginia Tech. Work performed at Virginia Tech National Center for Earth and Environmental Nanotechnology Infrastructure (NanoEarth). medRxiv preprint: <https://doi.org/10.1101/2020.11.18.20233353>

National Research Priority: COVID-19 and NSF-Growing Convergence

## The New York Times

### The Scientist, the Air and the Virus

Most of us had never heard of aerosol science before the pandemic. Then Virginia Tech's Linsey Marr showed up and became our tour guide to the invisible world of airborne particles.

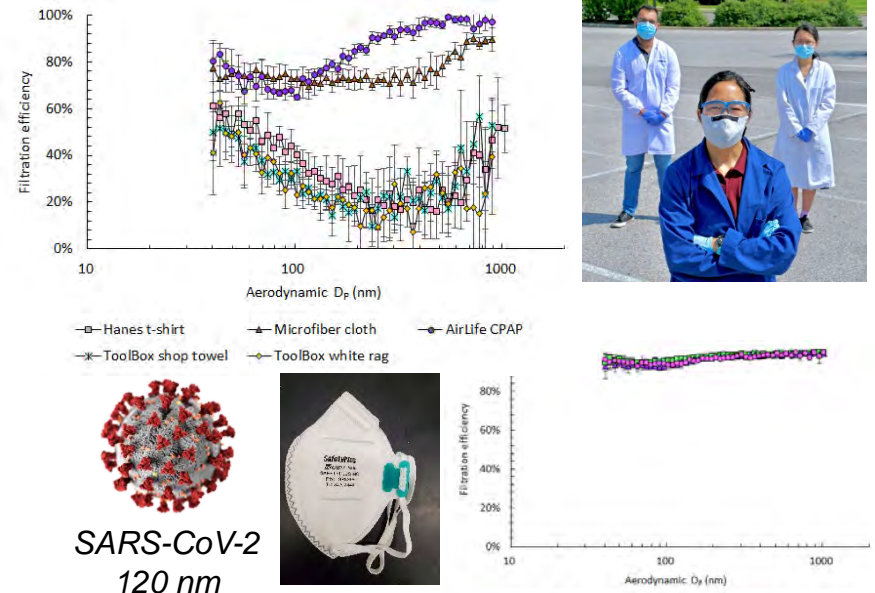



---

# ***NSF-Harnessing the Data Revolution***

# Self-Healing Liquid Metal Electrode Extends Life of Mg-Ion Battery

The increased demand for rechargeable lithium-ion batteries (LIBs) has placed a considerable strain on lithium and cobalt resources, which are becoming more expensive and are supplied by countries with high geopolitical risks. To mitigate these issues, rechargeable magnesium-ion batteries (MIBs) are emerging.

There is a major barrier to the widespread adoption of the MIBs, however: the anode material typically fails as a result of cracks and pulverization caused by the significant volume variation during a solid-solid phase transformation. In this work, gallium is employed to address the cracks and pulverization.

Micron-sized Mg-Ga solid alloy particles underwent a solid-liquid phase transformation as Mg was reversibly removed and incorporated at 40°C. The observed phase change significantly reduces the accumulation of stress within the anode. The material self-heals using this transformation, preventing the detrimental pulverization.

This new type of liquid anode material significantly shifted the state-of-the-art in MIBs, outpacing the longest MIB cycle life on record by approximately five times.

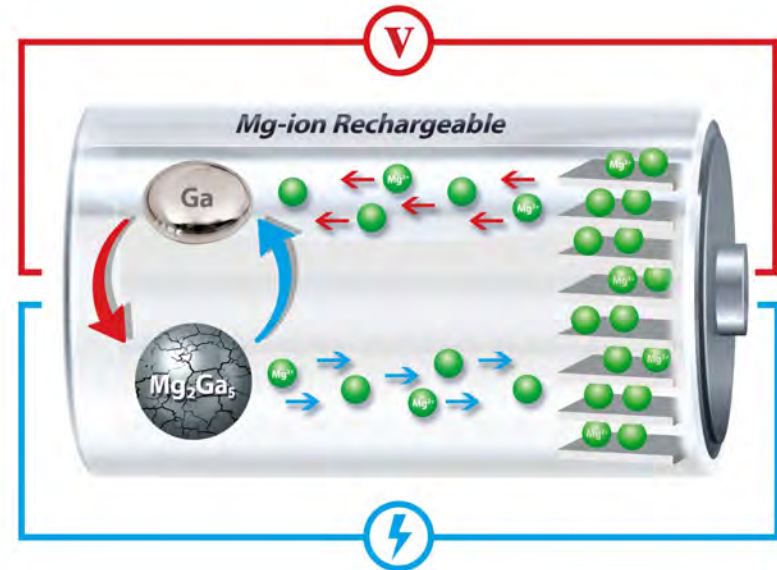

*The self-healing Mg-Ga rechargeable battery.*

Lin Wang, Samuel S. Welborn, Vivek B. Shenoy, and Eric Detsi, Dept. of Materials Science and Engineering, University of Pennsylvania

*Adv. Energy Mater.* 2019, 9, 1902086.

*National Research Priority: NSF-Harnessing the Data Revolution*

# A Novel Pixel Control Circuit Containing Non-linear Resistors and Thin Film Transistors for Active Matrix Flat Panel Displays

A novel flat panel display pixel control circuit containing non-linear resistors and thin film transistors is presented. Basic functionality of this mixed device approach is demonstrated by building a control circuit equivalent to the prototypical two transistor one capacitor pixel circuit. The new control circuit presented here replaces the switching transistor of the two transistor one capacitor circuit with a voltage divider formed by two amorphous metal non-linear resistors (AMNR). AMNR offer high-speed, low leakage current, and a simple device structure that does not use hydrogen during fabrication. High-speed, enabled by a Fowler-Nordheim tunneling conduction mechanism, allows AMNR to better match the speed of the LTPS drive transistors, compared to an IGZO TFT, but with a similarly low leakage current to IGZO TFT.

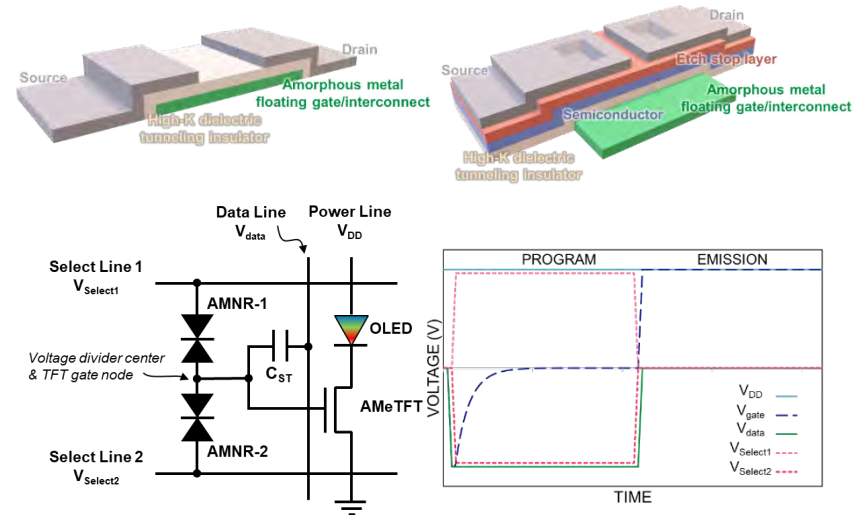

Upper: Schematic images of amorphous metal based thin-film electronic devices, AMNR (left) and AMeTFT (right). Lower: Circuit schematic (left) of a 2T1C circuit using AMNR and AMeTFT and simulation results demonstrating the circuit operation (right).

Sean W. Muir, Jose Eduardo Mendez, Dylan River Kearney, Amorphyx Inc. Work performed in part at ATAMI and MaSC facilities.

This work was supported by NSF (NNCI-2025489 and NNCI-1542101). *SID Symposium Digest of Technical Papers*. 2020; 52(S1).

National Research Priority: NSF-Harnessing the Data Revolution



# Designing Light-matter Hybrid States for High-performance Organic (Opto)Electronics

The project investigates optical and electronic properties of hybrid light-matter quasiparticles and their ability to manipulate photophysics and enhance charge transport in model organic semiconductors.

We demonstrated, for the first time, the strong coupling between organic molecules (rhodamine 6G, or R6G, incorporated in a polymer (PMMA) film) and a planar hyperbolic metamaterial (HMM), without any grating coupler (see Figures). This enables the use of this HMM metamaterial in novel polaritonic (opto)electronic devices that utilize properties of a planar HMM substrate

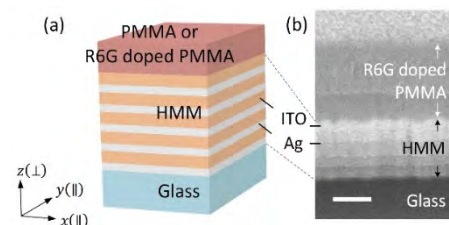

Fig. 1. (a) Schematics and (b) cross-sectional SEM image of a representative multilayer HMM coated with an R6G doped PMMA. The HMM comprises five alternating layers of 10.5 nm Ag and 17.7 nm ITO. The scale bar in the SEM image indicates 100 nm.

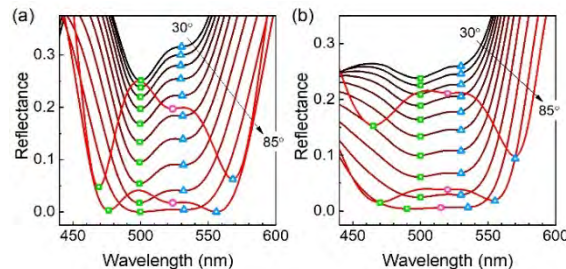

Fig. 2. (a) Theoretical and (b) experimental angle-dependent reflectance spectra for p-polarized light of the PMMA:R6G coated HMM structure demonstrating strong exciton-plasmon coupling.

E. K. Tanyi, J.D. B. Van Schenck, G. Giesbers, O. Ostroverkhova, L.-J. Cheng, Oregon State University, School of Electrical Engineering and Computer Science and Department of Physics. Work performed in part at MaSC of the NNI site.

This work was supported by NSF NNCI ECCS-1542101, DMR-1808258, and ECCS-1810067. *Optics Letters* (2020)

National Research Priority: NSF-Harnessing the Data Revolution

# Stage-Rocked Electron Channeling for Crystal Orientation Mapping

At the **NUANCE SEM** facility, a new orientation mapping system has been developed using a custom combination of highly precise image processing and a conventional SEM. By watching how the electrons channel into the specimen at different orientations, it is possible to create a highly accurate map of crystalline orientation without any geometric distortion by using computation to bring many different images into alignment over large stage shifts. Such a system could be bolted on to existing instruments at orders of magnitude lower cost than existing systems, dramatically increasing throughput and accessibility.

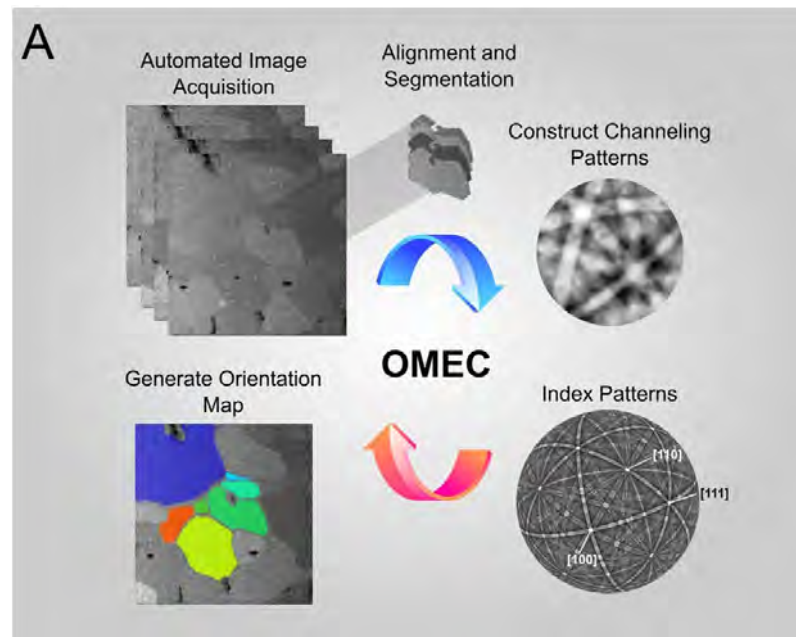

Workflow of the proposed Orientation Mapping by Electron Channeling (OMEC) method.

Hujdak, Myers, Grovogui, Dravid, Materials Science, Northwestern University and the NUANCE Center. Work was performed in the EPIC facility in the NUANCE Center at SHyNE.

This work was supported by NSF ECCS-1542205, Air Force Office of Scientific Research #FA8650-15-2-5518 and #FA9550-12-1-0280, MRSEC program (NSF DMR-1720139). *Scientific Reports*, 2018.

National Research Priority: NSF-Harnessing the Data Revolution

---

# ***NSF-Future of Work at the Human-Technology Frontier***



# Integration of MEMS Devices on Textiles with Strain-Engineered Grippers

In this work strain mismatched bimorphs are created by depositing 130nm Chrome at below 200 C on a 400nm silicon dioxide (SiO<sub>2</sub>) layer grown at 1000 C on a Si wafer. The upper metal film constrains the expansion of the lower SiO<sub>2</sub> layer thus when released from the substrate, the bilayer curls with a radius of curvature of  $144 \pm 41 \mu\text{m}$  that minimizes its potential energy and clasps onto the aligned fiber structure/ intersection. In contrast to adhesion, such mechanical tangling makes more kinds of carrier materials available. Antibacterial, conductive, heat-responsive and other functions can be brought in by fibre networks. The Mechanical grippers can also bring electronic contacts from one side of a mesh to the other, which is difficult to do on continuous thin films of other soft materials like silicone or polyimide.

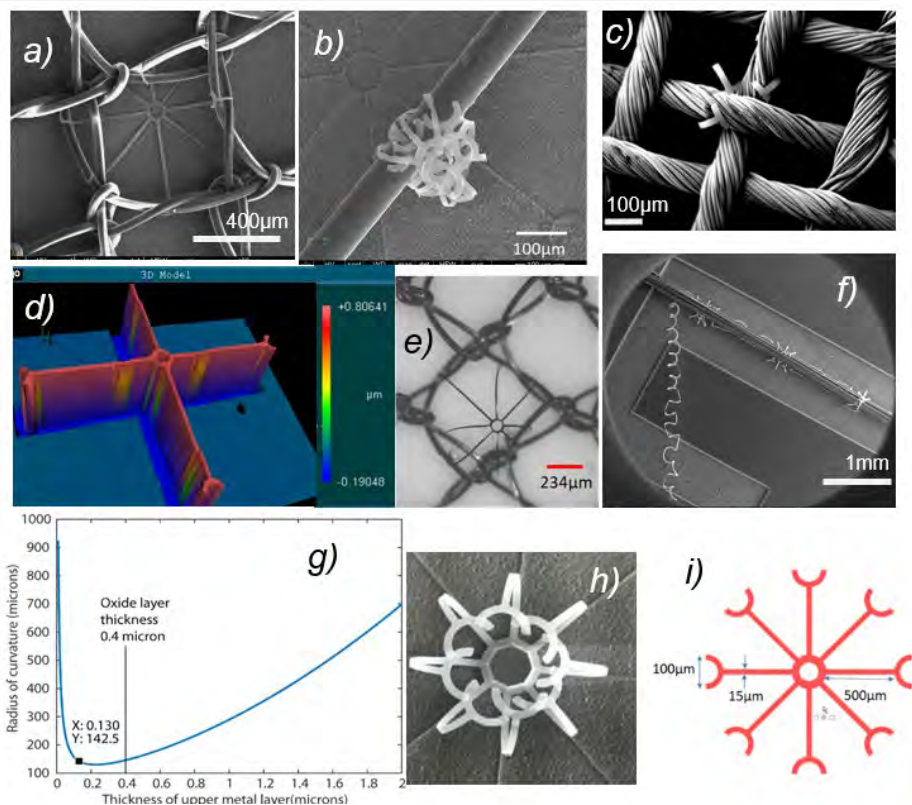

SEM images of Pop-up MEMS grippers transferred to a) Commercially produced Fabric Mesh b) Copper wire (diameter  $78 \mu\text{m}$ ) c) Woven Polyester Fabric d) Zygo Surface Mapt-3D Model. e) Microscope image of pop-up gripper on Fabric Mesh f) Grippers integrated into serpentine structures released on to an elastic fiber. g) Graph-Radius of curvature of the gripper versus metal layer thickness. h) Pop-up gripper after release from the Si-Wafer. i) Gripper Design in L-Edit

C.K. Harnett, M. Shafquatul Islam, Sushmita Challa, Electrical and Computer Engineering, University of Louisville, Canisha Ternival, University of Florida, Work performed at the University of Louisville Micro/NanoTechnology Center

National Research Priority: NSF-Future of Work at the Human-Technology Frontier

# Microstructure Engineering with Powder Fused Filament Fabrication (PF<sup>3</sup>) 3D Printing

The PF<sup>3</sup> process is a hybrid fused filament fabrication (FFF) process that uses a ceramic/metal-powder polymer filament that is 3D printed. Subsequently, the part undergoes binder removal by debinding and densification by sintering at elevated temperatures. Dr. Kunal Kate addresses current knowledge gaps in PF<sup>3</sup> material processing that prevent consistent printing and advanced engineering materials, and 3D printed structures with desirable microstructures and properties. As a representative example, Dr. Kate has shown bimodal particles' use in engineering novel composites microstructures with 80 wt.% loaded PF<sup>3</sup> 3D printing Hydroxyapatite (HAp) and HAp + 10 wt.% Si<sub>3</sub>N<sub>4</sub> composites. This work advances the fabrication of medical implants of custom strength with tailored geometries that are patient-specific and addresses gaps in the traditional press-and-sinter manufacturing process limited to making simple geometries like discs and plates.

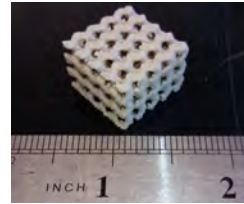

3D printed complex HAp structures with mathematically optimized structures

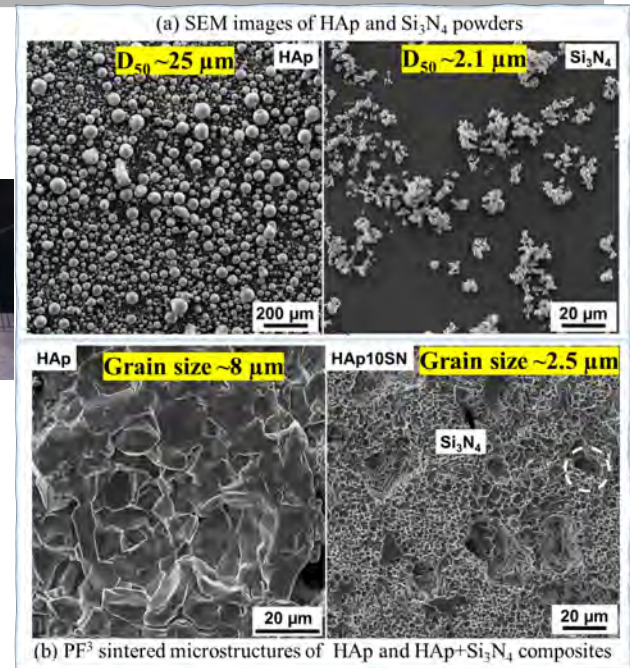

SEM images of HAp and HAp + 10 wt.% Si<sub>3</sub>N<sub>4</sub> composites showing 70% reduction in grain size due to smaller particles of Si<sub>3</sub>N<sub>4</sub> added to larger HAp powders resulted in improvement in the hardness from 81 HV to 384 HV

Dr. Kunal Kate, Mechanical Engineering, University of Louisville. This research used the core facilities at the University of Louisville Conn Center and the MicroNanoTechnology Center.

This work was supported by NSF #IIP 1450730. *Ceramics International* 2020.

National Research Priority: NSF-Future of Work at the Human-Technology Frontier

# Domain Characterization in Poled $\text{Mg:LiNbO}_3$ Using Auger Electron Spectroscopy

Magnesium-doped lithium niobate (MgLN) is an important ferroelectric material for nonlinear optical applications, including periodically poled (PP) devices that achieve high nonlinear conversion efficiency via quasi-phase matching. This work experimentally demonstrated the first use of Auger electron spectroscopy (AES) to characterize polarization domains in MgLN. The characteristic shift seen in the Oxygen KLL transition's peak energy between domains of opposite polarization shows a fundamental difference in MgLN's surface electron affinity. AES is beneficial because it is non-destructive, highly surface sensitive, and capable of domain characterization at a range of sizes (from millimeter to potentially sub-micron scale).

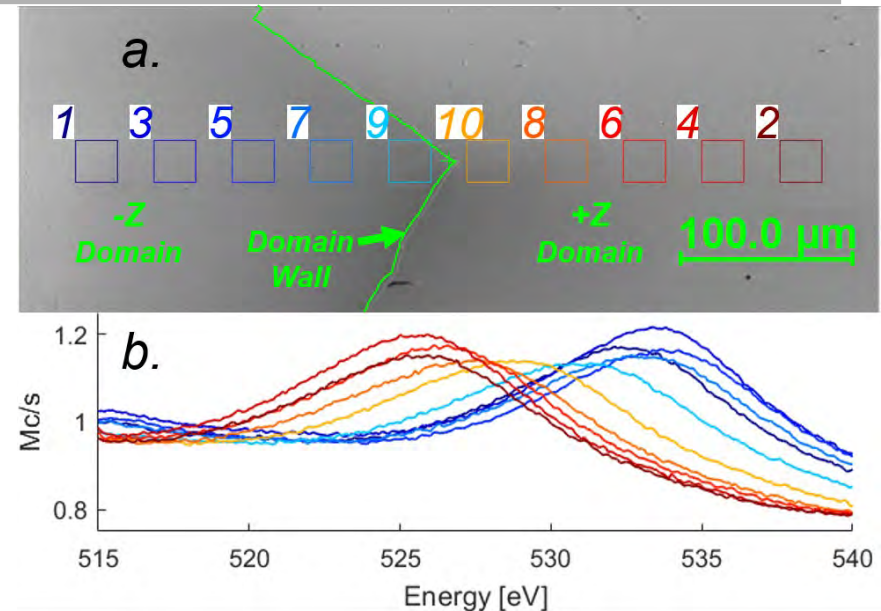

a) SEM image of MgLN crystal and AES survey areas, with poled, -Z domain on left side of image. b) Domain-differentiated Auger O-KLL spectra corresponding to color coded survey areas on MgLN above.

Torrey Mcloughlin<sup>1</sup>, Wm. Randall Babbitt<sup>1</sup>, Phillip A. Himmer<sup>2</sup>, and Wataru Nakagawa<sup>2</sup>, Montana State University, <sup>1</sup>Department of Physics, <sup>2</sup>Electrical & Computer Engineering Department. Work performed at MONT facilities: ICAL and MMF.

This work was supported by NSF Award # 1710128.

*National Research Priority: NSF-Future of Work at the Human-Technology Frontier*



# Strain-Engineered Perovskite with Enhanced Stability

## Scientific and engineering significance:

Perovskite devices, with their uniquely attractive properties for sensing, compliance, energy production, communications, and ergonomics, are among the most promising candidates to push the frontiers of *human-technology interactions*. However, the poor stability and reliability is the Achilles heel of all perovskite materials. This research applies a strain-engineering approach to produce high quality, reliable crystalline perovskite to overcome the major technical barrier for perovskite. The material synthesis and device fabrication method developed by Prof. Xu's lab used SDNI facilities and the assistance of SDNI staff engineers.

*Flexible  
single  
crystalline  
perovskite*

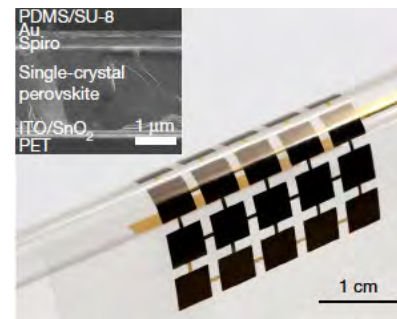

*Graded single crystalline perovskite*



Yusheng Lei, Yimu Chen, Ruiqi Zhang, Yuheng Li, Qizhang Yan, Seunghyun Lee, Yugang Yu, Hsinhan Tsai, Woojin Choi, Kaiping Wang, Yanqi Luo, Yue Gu, Xinran Zheng, Chunfeng Wang, Chonghe Wang, Hongjie Hu, Yang Li, Baiyan Qi, Muyang Lin, Zhuorui Zhang, Shadi A Dayeh, Matt Pharr, David P Fenning, Yu-Hwa Lo, Jian Luo, Kesong Yang, Jinkyong Yoo, Wanyi Nie, Sheng Xu.

*Nature*, 583, pages790–795, 2020.

*National Research Priority: NSF-Future of Work at the Human-Technology Frontier and  
NSF-Convergence Research*



# Metasurfaces for Near-Eye Augmented Reality

This work proposes and experimentally demonstrates a holographic display technology that casts virtual information directly to the retina so that the eye sees it while maintaining the visualization of the real-world intact. The key to our design is to introduce metasurfaces to create a phase distribution that projects virtual information in a pixel-by-pixel manner. Unlike conventional holographic techniques, our metasurface-based technique, based on Pancharatnam-Berry phase elements made of silicon, is able to display arbitrary patterns using a single passive hologram. With a small form-factor, the designed metasurface empowers near-eye AR, excluding the need for extra optical elements, such as a spatial light modulator, for dynamic image control.

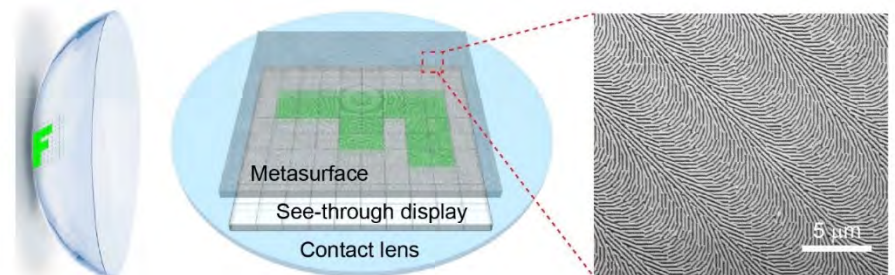
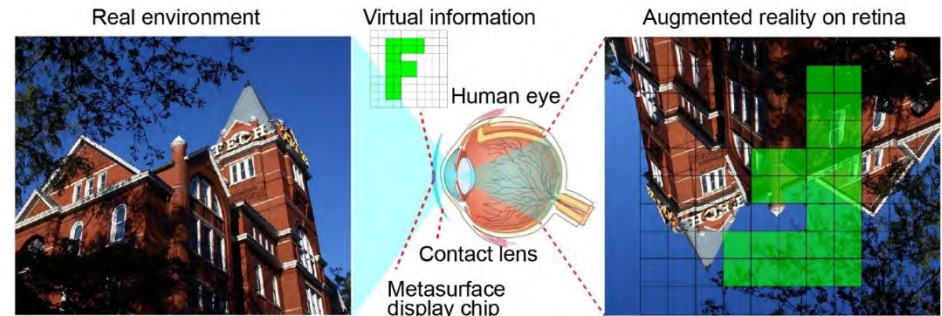

*Schematic of metasurface enable device. The lower-right image is the SEM micrograph of a small portion of the metasurface comprises the predesigned distribution of silicon nanobeams.*

Shoufeng Lan, Xueyue Zhang, Mohammad Taghinejad, Sean Rodrigues, Kyu-Tae Lee, Zhaocheng Liu, and Wenshan Cai, ECE, Georgia Institute of Technology. Work performed at Georgia Tech's Institute for Electronics and Nanotechnology.

This work was supported by NSF Award # ECCS-1542174. *ACS Photonics* 2019, 6, 864–870

*National Research Priority: NSF-Future of Work at the Human-Technology Frontier*

---

# ***NSF-Navigating the New Arctic***

# Orientation of Laboratory-Prepared Snow Microstructures

This work links novel combinations of existing field and laboratory techniques that allow for the efficient extraction and full characterization of both c-axis and a-axis crystallographic orientations of individual snow grains from a snowpack using electron backscatter diffraction (EBSD). The crystallographic orientation obtained will give an understanding to a variety of physical processes occurring within snow, including wet and dry snow metamorphism, mechanical behavior, sintering, and the dielectric response of snow to incident electromagnetic radiation.

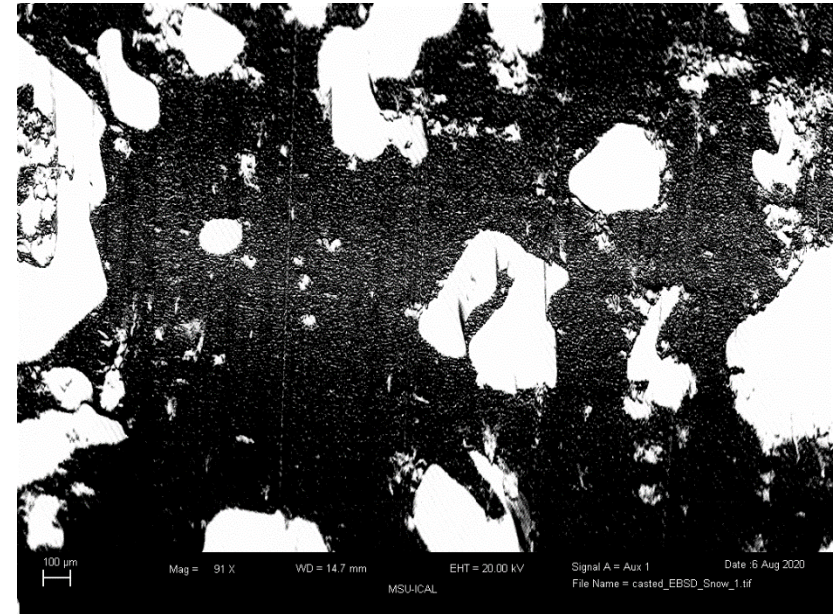

*Backscatter image of depth hoar snow crystals casted in Dimethyl Phthalate.*

Kevin Hammonds, Evan Schehrer, College of Engineering, Montana State University. Work performed at MONT facility ICAL.

NASA, Nasa New Investigator Program Grant in Space and Earth Science.

*National Research Priority: NSF-Navigating the New Arctic*

# CTD-on-a-Chip: Enabling Polar In-Situ Ice-Ocean Data Collection

CTDs are oceanographic instruments that measure the conductivity, temperature, and pressure of a water parcel to calculate salinity. *In situ* salinity measurements can be used to estimate melt rates in ice-covered locales. This work looked at developing a highly-confined conductivity cell that used vertical electrodes to minimize the effects of nearby structures and materials to improve near-interface measurements. The trenches were etched with a DRIE Bosch process with a decoupling thermal oxidation layer. The Cr/Au electrodes were sputtered to improve sidewall coverage. Results showed promise in the formation of the structure down to central “fin” widths of 10um, and while sputtering improved step coverage, high roughness from the DRIE proved challenging for uniform metalization. Future work will look at reducing the roughness of the DRIE for improved coatings of the sidewalls.

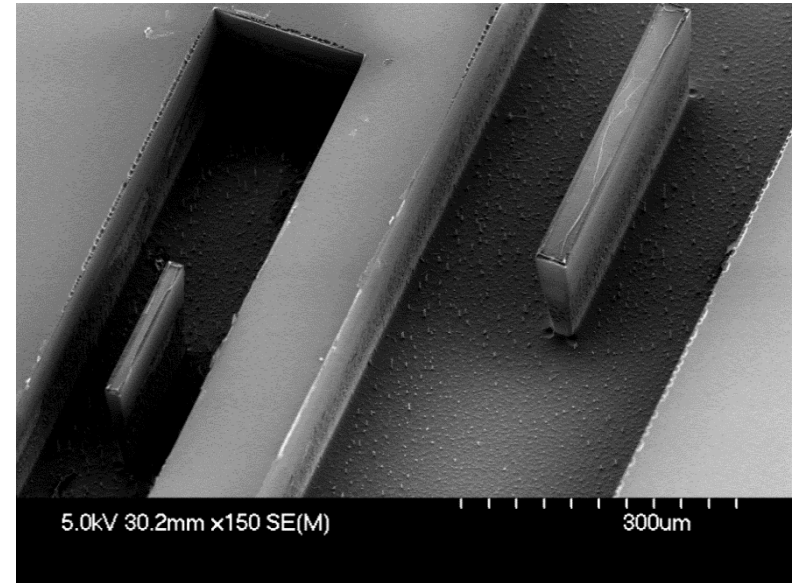

SEM micrograph showing the channel and fin structure, with two different sizes shown.

Ben Hurwitz and Britney Schmidt, Planetary Habitability and Technology Lab, School of Earth and Atmospheric Sciences, Georgia Institute of Technology. Work performed at Georgia Tech's Institute for Electronics and Nanotechnology.

This work was partially supported by a SENIC Seed Grant (NSF ECCS-1542174).

*National Research Priority: NSF-Navigating the New Arctic*



---

# ***NSF-Mid-Scale Research Infrastructure***

# Nanomodulated electron beams via electron diffraction from a free-standing silicon grating

ASU has demonstrated a new method to generate relativistic electron beams with current modulation at the nanometer scale. The short modulation period enables the production of hard x-rays from inverse Compton scattering and serves as the light source for the CXFEL. The current modulation is produced by diffracting relativistic electrons in single crystal Si, accelerating the diffracted beam and imaging the crystal structure, then transferring the image into the temporal dimension via emittance exchange. In this approach, the electrons are transmitted through the grating, and the grating is producing contrast due to the presence/absence of the grating fingers, but the diffraction itself is due to the Si atomic structure rather than the grating. The limitation on this modulation period is set by the minimum feature size. Fabricating gratings with variable width and spacing in the 100 nm range provides multicolor attosecond X-ray pulses.

*Varying the pitch and line width of the Si grating changes the period and duration of the electron bunches*



W. Graves, Dept of Physics and T. J. Thornton, School of Electrical, Computer, and Energy Engineering, Arizona State University.

*National Research Priority: NSF-Mid-Scale Research Infrastructure*

---

# ***NSF INCLUDES***

# Virtual NanoTechnology Entrepreneurship Challenge for Undergraduate Entrepreneurs

- Reach: 3 teams, 7 students, 3 faculty members, 2 institutions
- Awarded teams \$1,000 (Multicultural & Underserved Nanoscience Initiative-MUNI team awarded \$5,000)
- “Recognizing aspiring scientific entrepreneurs who wish to develop nanotechnology-based products for social good”
- Nano Image Analysis (MUNI)
  - POC: Tyson Gregory (undergrad)
  - Faculty lead: Sambit Bhattacharya
- Human Exhale Tool
  - POC: Qishen Huang (PhD student)
  - Faculty Lead: Peter Vikesland
- Nanoporous PET Aerogels
  - POC: Connor Slamowitz (undergrad)
  - Faculty Lead: Robert Moore



## Panelist Feedback

### Does the NTEC program offer a valuable student learning experience?

- “Yes! This type of thought process and learning is lacking in a traditional curriculum. This experiential/hands on learning is vital and will be something they remember for many years to come!”
- “Yes- it was obvious that the students derived strong value that, more importantly, is not present in other coursework, capstone projects, or other University offerings. Students directly commented that this experience was far different from any other project previously pursued during their academic year, and this became apparent through their excitement about their work and discussion of lessons learned.”

### How might we improve the NTEC program moving forward?

- “Hard to say, given the inconveniences caused by COVID-19! I felt the adaptations made in response were appropriate, and that students were still able to produce quality work, which speaks to the mentorship of the NTEC leaders and faculty advisors.”

## 7 Week Plan – NSF I-Corps-like Experience

Week	MVP	Business Model Generation
1		Write your business thesis
2		Customer segments and value propositions
3		Channels and customer relationships
4		Revenue streams
5		Key resources, activities, and partnerships
6		Cost structure
7		*NTEC Launch Lunch

National Research Priority: NSF-INCLUDES



# Take-out Science Brings Nanotechnology to People's Homes

Live broadcast of samples imaged with desktop SEM aimed at K-12 audiences

New theme weekly (e.g. housefly, pollen, toilet paper, animal hair)

Online engagement through website and social media

Experience with on-the-road outreach helped us launch this program quickly

>4,800 views over fourteen shows

Collaborated with colleagues at peer NNCI sites (nano@Stanford, SDNI, CNF, NNI)

Faculty, students, and staff at NC State, UNC-Chapel Hill, and Duke. Work performed at Duke's Shared Materials Instrumentation Facility, NC State's Analytical Instrumentation Facility, the NC State Nanofabrication Facility, and the Chapel Hill Analytical and Nanofabrication Laboratory.

Work supported by NSF Award # ECCS-1542015.

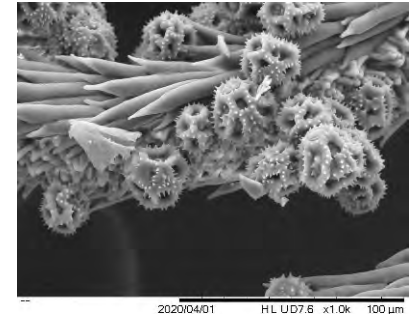

RTNN staff member Dr. Holly Leddy with June the Science Dog set up to broadcast a show from home (left) SEM image of pollen (right)

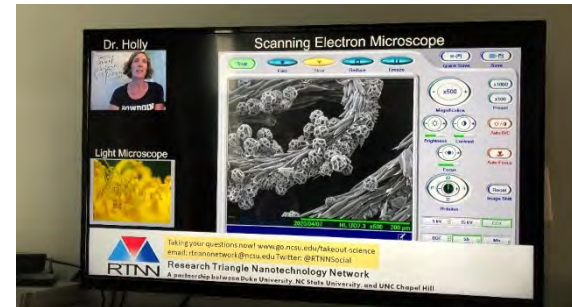

Viewer-supplied photo of their television screen during a live show

*“My teenage sons and I are really enjoying your ‘take-out’ science lessons! Thanks for doing this! It makes our quarantine time more fun and interesting.”*

National Research Priority: NSF-INCLUDES

# Demonstrations of microscopic (SEM/TEM) and surface analysis techniques

This work supported a site visit for ten students enrolled in GEOS 4042/6042, Environmental Analytical Instrumentations, class at Georgia State University.

After learned the theory and operational procedures of each instruments, the students visited the Materials Characterization Facility (MCF) twice for demonstrations on SEM/TEM, AFM, XRD, XPS and TOF-MS.

The students, in groups of 3-4, rotated on each station and spent 30 minutes with each instrument specialist who went over basic terminology and results from a typical sample.

The demonstrations were very powerful for the students to visualize the concepts they learned in class. The graduate students in the class were pleased to learn of potential avenues to obtain characterization data they may need in their work.

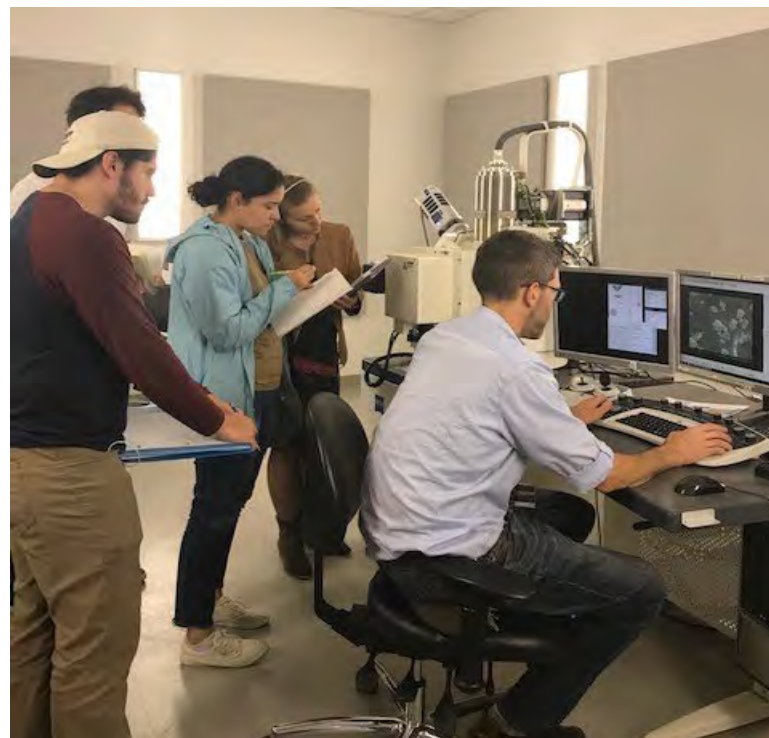

*Class demonstration for students enrolled in GEOS 6046, Environmental Analytical instrumentations, at Georgia State University.*

Nadine Kabengi, Georgia State University. Work performed at Georgia Tech's Institute for Electronics and Nanotechnology.

This work was supported by NSF Award # ECCS-1542174 (Catalyst Grant)

*National Research Priority: NSF-INCLUDES*

---

# ***NAE Grand Challenge-Make Solar Energy Economical***

# Demonstration of Nano-macro Scale Manufacturing of Perovskite Solar Cells

This work targets the scalability of the deposition of two solution phase films for the high speed manufacture of perovskite solar cells. These films include a water-based tin-oxide nanoparticle dispersion at 50 nm thick and a metal-organic halide at 500 nm thick. Both films are deposited at 2.5 m/min using a slot die followed by an annealing step using Intense Pulsed Light (IPL). The IPL lamp source is tuned to flash every 0.5 seconds for 100 microseconds. The resulting devices produce large-area ( $> 1\text{cm}^2$ ) solar cells on plastic with a device efficiency of  $\sim 10$  percent. The IPL process effectively reduces the footprint for the roll-to-roll manufacturing line by several orders of magnitude. This demonstration of the nano to meter scale manufacturing will be scaled to upwards of 10 m/min.

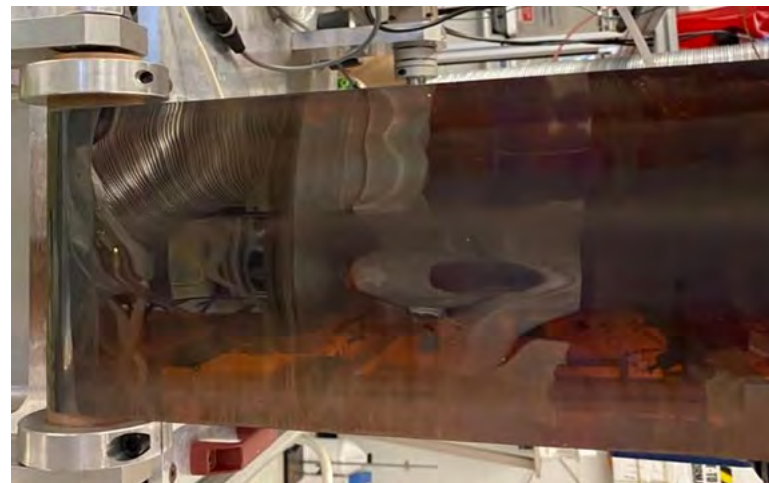

Picture of Roll-to-roll processed flexible perovskite devices manufactured at 2.5 m/min producing large area cells at  $\sim 10$  percent efficiency.

Siva Pakanati, Blake Martin, Sashil Chapagain, Peter Armstrong, Craig Grapperhaus and Thad Druffel, Conn Center for Renewable Energy Research, Speed School of Engineering, College of Arts and Sciences, University of Louisville. Work performed at University of Louisville's Conn Center for Renewable Energy Research.

This work is funded by the U.S. Department of Energy (DoE) Solar Energy Technologies Office Award # DE-EE0008752.

*National Research Priority: NAE Grand Challenge-Making Solar Energy Economical*



# Phonon Dispersion Relation of Graphitic $BC_x$

Graphite is the state-of-the-art anode material for lithium-ion batteries. Our research concerns modifications to the graphitic network (chemical and physical) to assess their effects on battery metrics such as compatibility with new chemistries (e.g., sodium-ion batteries), energy density, rate capability, and cyclability.

Our most recent work concerns the chemical modification of disordered graphitic carbon materials using boron ( $BC_x$ ). The studies shown at right investigate the dependence of the Raman D peak position on the excitation energy, the so-called “phonon dispersion relation.” The diminished phonon dispersion relation seen for graphitic  $BC_3$  (green diamonds) over that of pure carbon  $C'$  (black diamonds) is direct evidence of ordered boron substitutions within the lattice.

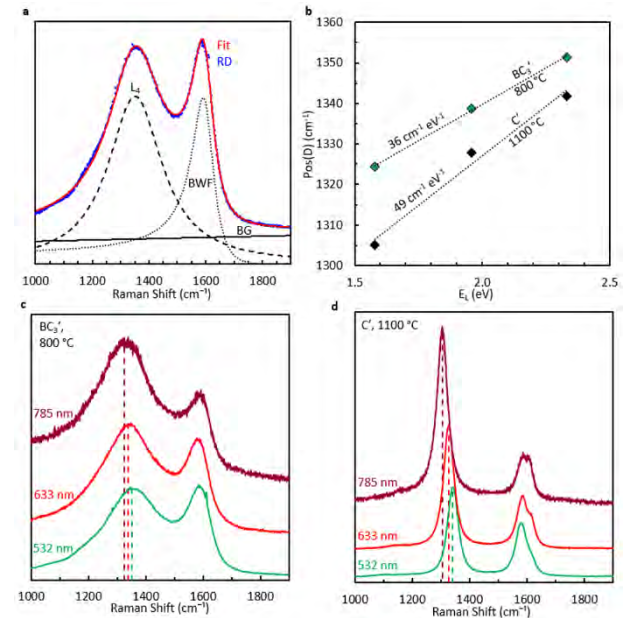

Comparison of phonon dispersion of pure carbon and graphitic  $BC_x$  by Raman spectroscopy at three excitation energies.

Devin McGlamery and Nicholas P. Stadie. Work performed at MONT Facility, Center for Biofilm Engineering (CBE)

Funding provided by the American Chemical Society Petroleum Research Fund

National Research Priority: NAE Grand Challenge-Make Solar Energy Economical

# Direct Correlation of Charge Carrier Transport to Local Crystal Quality in LHPs

In lead halide perovskites (LHPs), defects derived from solution processing have been implicated as an important determiner of photophysical properties. However, a direct correlation between the functional properties of these materials and the local crystal structure has remained elusive, in part because lattice disorder occurs on length scales below the resolution achievable by conventional characterization techniques. To address this knowledge gap, we have combined ultrafast pump-probe microscopy and EBSD to directly correlate charge carrier transport with the local diffraction pattern contrast, which is an indicator of crystal quality. Spatial correlation of these measurements strongly suggests that even on individual single crystal  $\text{CsPbBr}_3$  domains, microscopic variability in the crystal quality profoundly impacts the efficiency of charge carrier transport.

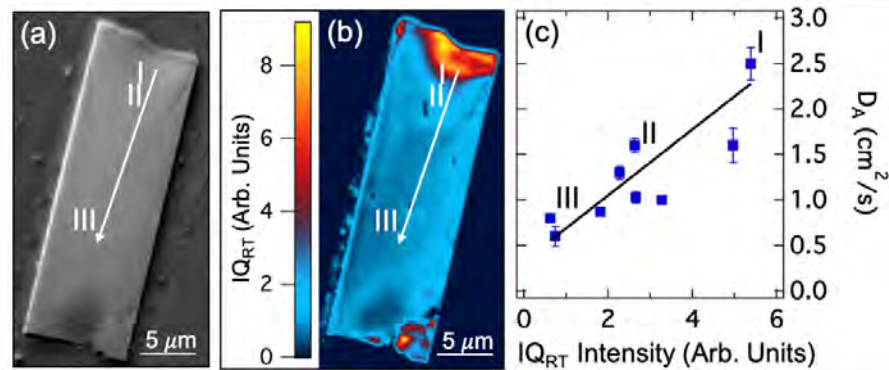

Correlation between image quality and ambipolar diffusivity. Panel (a) shows a SEM of a single crystal  $\text{CsPbBr}_3$  domain, and panel (b) shows a corresponding  $\text{IQ}_{\text{RT}}$  map.  $\text{IQ}_{\text{RT}}$  measurements across the domain range from 0 to 9.2, with mostly moderate values ( $\sim 3$ ) throughout the bulk of the domain. Panel (c) shows a plot of the measured diffusion coefficients vs. average  $\text{IQ}_{\text{RT}}$  for nine separate locations on the LHP domain. The  $\text{IQ}_{\text{RT}}$  values, which range from 0.63 to 5.39, are determined by averaging over a  $0.56 \mu\text{m}^2$  area in the same nine locations in which diffusivity measurements were collected. Error bars correspond to one standard deviation. The black solid line is a guide to the eye.

Casey L. Hickey and Erik M. Grumstrup. Work performed at MONT facility ICAL.

Work was funded by DOE Grant #DE-SC0014128, Beckman Young Investigator Program and NSF GRFP Grant #1632134. *Nano Lett.*, 2020, 20 (7), 5050-5056.

National Research Priority: NAE Grand Challenge-Make Solar Energy Economical

# Defect engineering of p-type silicon heterojunction solar cells

In this work, we integrate defect engineering methods of gettering and hydrogenation into silicon heterojunction (SHJ) solar cells fabricated using low-lifetime commercial-grade p-type Czochralski-grown monocrystalline and high-performance multicrystalline wafers. We independently assess the impact of gettering on the removal of bulk impurities such as iron as well as the impact of hydrogenation on the passivation of grain boundaries and B-O defects. The results demonstrate solar cells with independently verified 1-sun open-circuit voltages of 707 and 702 mV on monocrystalline and multi-crystalline silicon wafers, respectively, with a starting bulk minority-carrier lifetime below 40 microseconds. These remarkably high open circuit voltages reveal the potential of inexpensive low-lifetime p-type silicon wafers for making devices with high efficiencies without needing to shift towards n-type substrates.

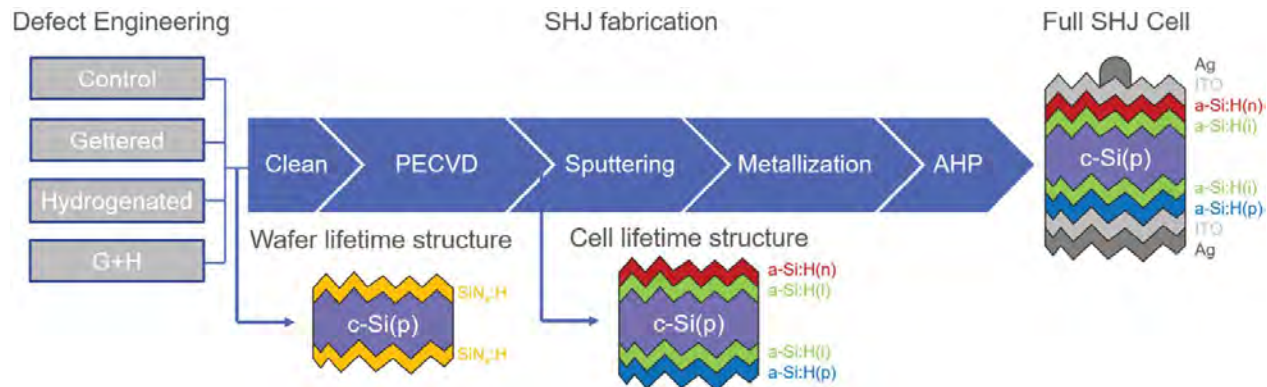

Process flow diagram for the fabrication of defect-engineered p-type SHJ lifetime structures and solar cells

Daniel Chen, University of New South Wales. Work performed at NCI-SW.

Prog. Photovolt. Res. Appl., pp. 1-15, Nov. 2019.

National Research Priority: NAE Grand Challenge-Make Solar Energy Economical

# 1.27 kV Etch-Then-Regrow GaN p-n Junctions with Low Leakage for GaN Power Electronics

High performance GaN p-n junctions with regrown p-GaN by metalorganic chemical vapor deposition on dry-etched surfaces have been demonstrated. The breakdown voltage reaches 1.27 kV and the differential on-resistance is  $0.8 \Omega\cdot\text{cm}^2$ . The effects of etching powers and surface treatments on the reverse leakage characteristics of the regrown p-n junctions have been investigated. Lowering the etching power is very effective to reduce the leakage currents and increase the breakdown voltages. Further analysis reveals that the charge concentration at the regrowth interface plays a critical role in the performance of the regrown samples. This work has demonstrated a practical and viable method to realize high performance regrown p-n junctions for various advanced GaN power electronics.

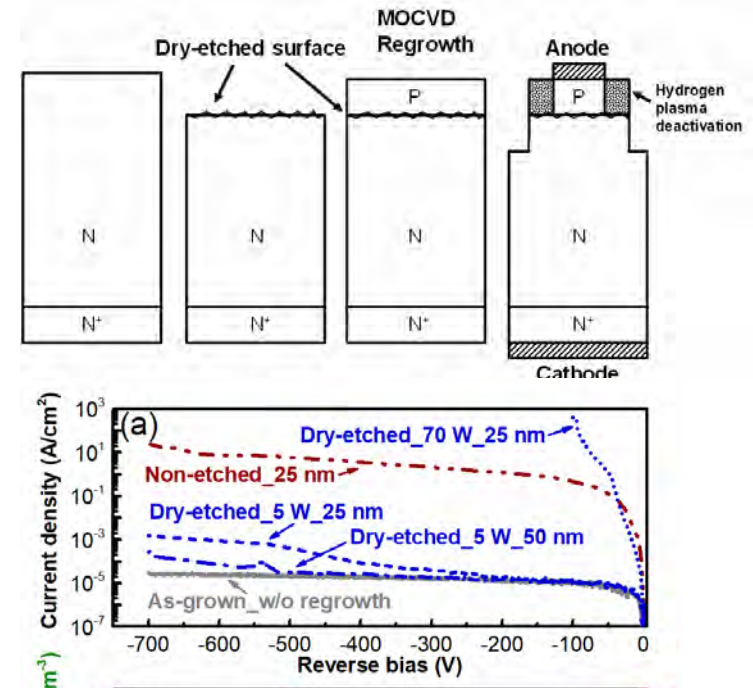

Process flow and reverse bias current-voltage characteristics of etch-then-regrow GaN pn junctions

Y. Zhao, School of ECEE, Arizona State University. Work performed at NCI-SW.

This work was supported by NSF Award # ECCS-1542160. *IEEE Electron Device Letters*, vol. 40, no. 11, pp. 1728 - 1731, Nov. 2019.

National Research Priority: NAE Grand Challenge-Make Solar Energy Economical



# Rise of Terrestrial Vertebrates during the Triassic Period

During the Triassic Period (252-200 million years ago), terrestrial vertebrates transformed from the “alien” to the more familiar (e.g. amphibians, mammal relatives, reptiles)

Chronicling this transformation is challenging due to lack of robust anatomical information

This work focuses on Triassic faunas that have living members (e.g. mammals, birds) as well as those that evolved and went extinct (e.g. early dinosaurs)

Using computed tomography (CT) to characterize fragile specimens encased in rock

Identified some of world’s oldest amphibians and will use this technique to better understand evolution of ecological shifts in reptiles

Brenen Wynd, Sterling Nesbitt, Michelle Stocker, and Andrew Heckert., Joint Department of Geosciences, Virginia Tech. Work performed at Duke’s Shared Materials Instrumentation Facility.

Work supported by Virginia Tech Geosciences Charles J. Gose Research Award in addition to the John A. and Katherine G. Jackson School of Geosciences and the Geology Foundation at the University of Texas Austin. *J. Vertebr. Paleontol.* 39 (2020).

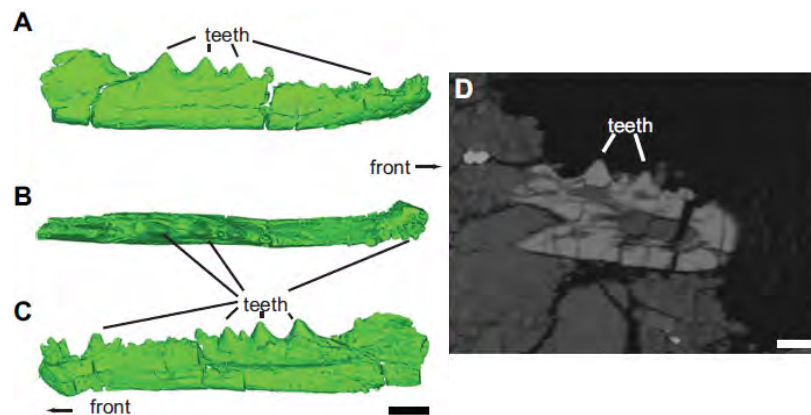

3D reconstructions of a delicate and rare reptile jaw from the Triassic in lateral (A), occlusal (B), and medial (C) views generated from high quality CT data (D). Scale bars = 1 mm



CT scan of Triassic frog ilium (hip bone)

National Research Priority: NSF-Understanding the Rules of Life

## Initial Cohort of RTNN Kickstarter Projects in 2016

Developed “nanocoining” process to create nanostructured surfaces

Nanopatterns can manipulate light or change surface interactions, useful in a range of applications

Received subsequent NSF SBIR (2017) and US Army STTR (2019), SBIR (2020) funding

## FIRST PRODUCT LAUNCHED: flexible micropatterned mold for nanoimprint lithography (NIL)

Sub-micron patterns will be added to inventory soon

## Nanocoining process to fabricate plasmonic devices

Demonstrated nanocoining as a key process in the scalable manufacturing of large-area metamaterials

Seamlessly nanopattern and micropattern cylindrical molds for roll to roll NIL hundreds of times faster than electron-beam lithography

Stephen Furst and Nichole Cates, Smart Material Solutions, Inc. Work performed at NC State’s Analytical Instrumentation Facility and the NC State Nanofabrication Facility.

Work supported by the NSF (IIP-1738387) and US Army (W911SR20C0005, W15QKN19C0044).

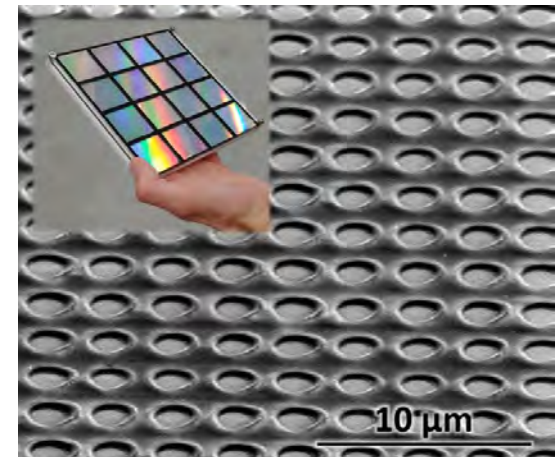
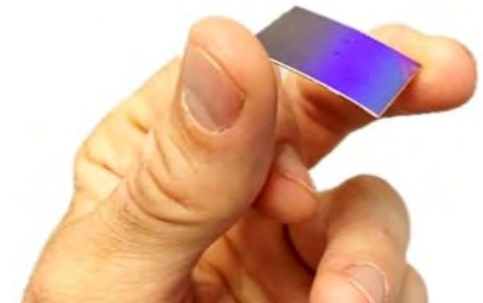

*National Research Priority: NAE Grand Challenge-Make Solar Energy Economical and White House FY2022, Administration R&D Budget Priorities-Energy*

---

# ***NAE Grand Challenge-Engineer the Tools of Scientific Discovery***

# Epitaxial Oxides on Glass: A Platform for Integrated Oxide Devices

We have demonstrated the successful fabrication of transition metal oxide (TMO)-on-glass layer stacks via direct deposition. The resulting samples feature epitaxial, ultrathin strontium titanate (STO) on thick  $\text{SiO}_2$  layers, forming STO-buffered  $\text{SiO}_2$  pseudo substrates. A wide range of potential applications for the STO-buffered  $\text{SiO}_2$  pseudo substrates demonstrated here can be envisioned, owing, in large part, to the ease of manufacture. The epitaxial compatibility between STO-buffered  $\text{SiO}_2$  and a plethora of functional TMO materials will facilitate the fabrication of novel TMO devices on an electrically and optically isolated platform.

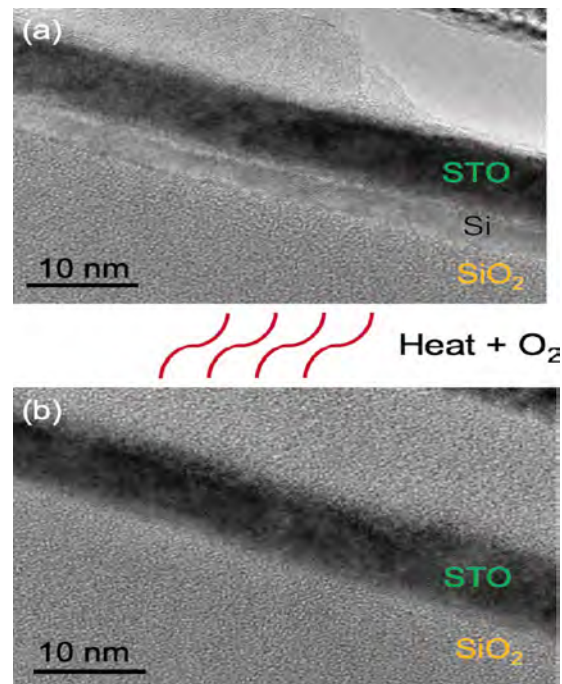

Cross-sectional HREM images of (a) as-grown sample and (b) sample after  $\text{O}_2$  annealing.

J. E. Ortmann, Dept. of Physics, The University of Texas, Austin. Work performed at NCI-SW.

*ACS Applied Nano Materials*, vol. 2(12), pp. 7713–7718, December 2019.

*National Research Priority: NAE Grand Challenge-Engineer the Tools of Scientific Discovery*



# Ultrafast Pyroelectric Photodetection with On-Chip Spectral Filters

Thermal detectors are uniquely capable of sensing incident radiation for any electromagnetic frequency though response times are typically on the millisecond scale

By combining a pyroelectric thermal detector with wavelength-selective nanoparticle absorbers can achieve ultrafast response of a pyroelectric sensor with near-infrared responsivity

On-chip spectral filters are realized through control of nanoparticle size

Jon W. Stewart, Jarrett H. Vella, Wei Li, Shanhui Fan & Maiken H. Mikkelsen, Dept. of Electrical and Computer Engineering, Duke University; Work performed at Duke's Shared Materials Instrumentation Facility.

Work supported by Air Force Office of Scientific Research (FA9550-18-1-0326, FA9550-17-1-0002), US DOE (DE-FG02-07ER46426), and the DoD (Graduate Fellowship). *Nat. Mater.*, 19 (2020).

*National Research Priority: NAE Grand Challenge- Engineer the Tools of Scientific Discovery*

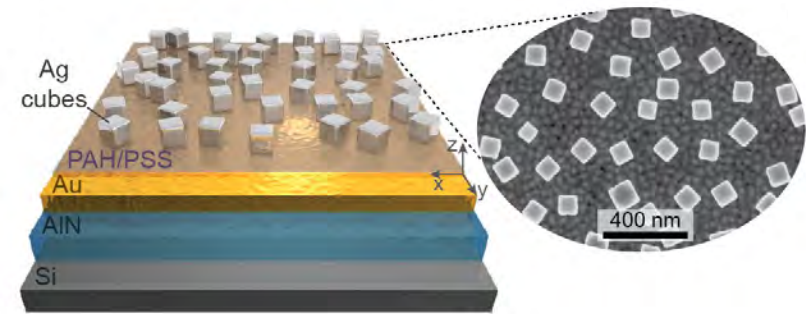

*Schematic of the vertical detector structure with a plasmonic metasurface deposited on a polycrystalline AlN pyroelectric layer*

*An SEM image of the fabricated metasurface with 100 nm Ag cubes*

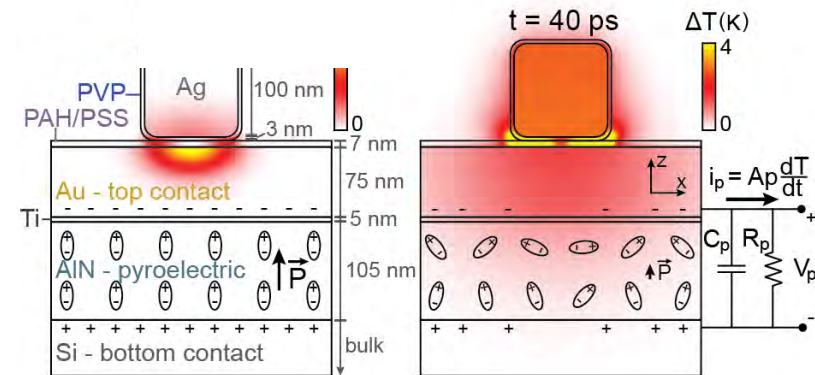

*Depiction of thermal impulse response within a single metamaterial element 1 ps (b) and 40 ps (c) after an excitation pulse*

---

# ***NAE Grand Challenge-Provide Access to Clean Water***

# Biohybrid Nanofibers for Heavy Metal Removal from Water

Adsorption is an inexpensive and effective means to remove heavy metals from groundwater.

Polyvinyl alcohol (PVA) was electrospun into nanofibers containing  $\text{MnCl}_2$

Manganese-oxidizing fungi (*Coprinellus* sp. and *Coniothyrium* sp.) were immobilized onto nanofiber surfaces

Upon attachment to manganese chloride-seeded nanofibers, fungi catalyzed the deposition of manganese oxide that served to adsorb heavy metal ions

Fungi-nanofiber hybrids removed heavy metals from groundwater

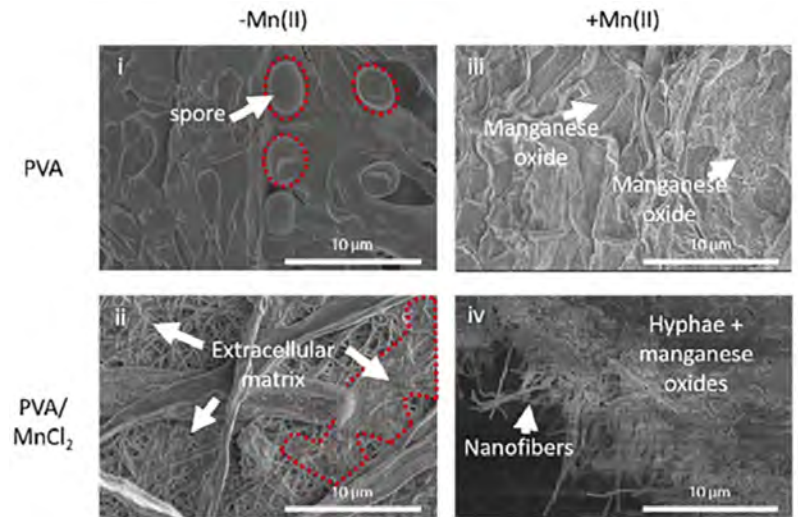

SEM images confirmed attachment of fungi to nanofibers  
i. Presence of spores indicated that nanofibers did not inhibit fungal reproduction  
iii. *Coniothyrium* sp. catalyzed the growth of sheet-like manganese oxide particles in Mn(II)-containing media  
ii., iv. Extracellular matrix appeared at the interface of nanofibers and hyphae (fungal cells)

Yaewon Park, Shuang Liu, Terrence Gardner, and Ericka Ford. Department of Textile Engineering, Chemistry, and Science and Department of Crop and Soil Science, NC State University. Work performed at NC State's Analytical Instrumentation Facility.

This work was supported by NSF (CHE-1407180), Water Resources Research Institute (17-02-SG), North Carolina Sea Grant (R/MG-1708), the Nonwovens Institute (14-177 NC). *J. Eng. Fibers Fabr.*, 13 (2020).

National Research Priority: NAE Grand Challenge-Provide Access to Clean Water

# Fabrication of Anti-biofouling Water Purification Membranes

Nanofiltration and reverse osmosis membranes commonly used in desalination, but biofouling remains a widespread problem

In this proof of concept work, 2-aminoimidazole (2-AI) was incorporated into polyamide active layers of membranes

Used three methods that could easily be integrated into existing manufacturing processes

2-AI known to disrupt biofilm formation mechanisms

2-AI membranes significantly inhibited the formation of biofilms compared to controls

Ariel Atkinson and Orlando Coronell, Dept. of Environmental Sciences and Engineering, University of North Carolina at Chapel Hill. Work performed at the Chapel Hill Analytical and Nanofabrication Laboratory. Collaboration with Agile Sciences, Inc., Raleigh, NC

Work supported by NSF (CBET-1264690, CBET-1336532). *J. Membr. Sci.*, 579 (2019).

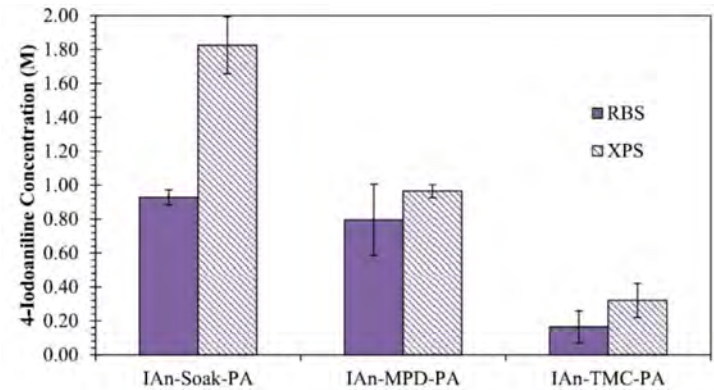

2-AI bulk (RBS) and surface (XPS) concentrations in the membranes were high enough to prevent biofilm formation

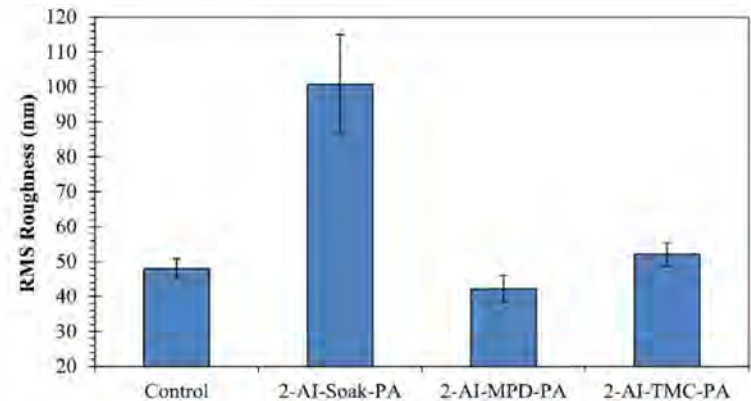

2-AI presence and action was responsible for biofilm inhibition as opposed to physico-chemical differences (e.g. roughness, hydrophobicity, charge)

National Research Priority: NAE Grand Challenge-Provide Access to Clean Water





# Secures \$3M Investment

Southwest Virginia-based and woman-led, early stage clean technology company delivers a patented water purification solution that cleans water from virtually any source

The Center for Innovative Technology (CIT) and The Pearl Fund announced that CIT GAP Funds and The Pearl Fund L.P. led a \$3 million seed round investment in Micronic Technologies, Inc, with participation from CAV Angels. Located in a Southwest Virginia Opportunity Zone, Micronic Technologies is a developer of a breakthrough Zero Liquid Discharge (ZLD) water purification technology that reduces wastewater volume by 95% and removes over 99% of contaminants in a sustainable and cost-effective way that hasn't been achievable until now.

**Source** → **Product**

**MICRONIC TECHNOLOGIES™**  
The Clean Water Solution

**MicroEvap™ Technology**

Work partially performed at Virginia Tech National Center for Earth and Environmental Nanotechnology (NanoEarth).

CIT GAP Funds and The Pearl Fund Lead \$3M Opportunity Zone Investment in Micronic Technologies.

*National Research Priorities: NAE Grand Challenge-Providing Access to Clean Water and NNI Signature Initiative-Water Sustainability through Nanotechnology*

---

## ***Other NAE Grand Challenges***

# Multiphase Flow in 2D Porous Micromodels

Multiphase flow in porous media is relevant to a broad range of applications in the energy and environmental sectors, such as enhanced oil recovery and geologic carbon sequestration.

Our research aims to qualify the microscale interactions of multiphase flows using a microfluidic platform called micromodel.

We have been taking advantage of Montana Microfabrication Facility (MMF) to design and fabricate our micromodels, which are imperative to this study.

This research will greatly help further our understanding of multiphase flow in porous media at the microscale and improve our capability to guide and improve practical operations at much larger scale.

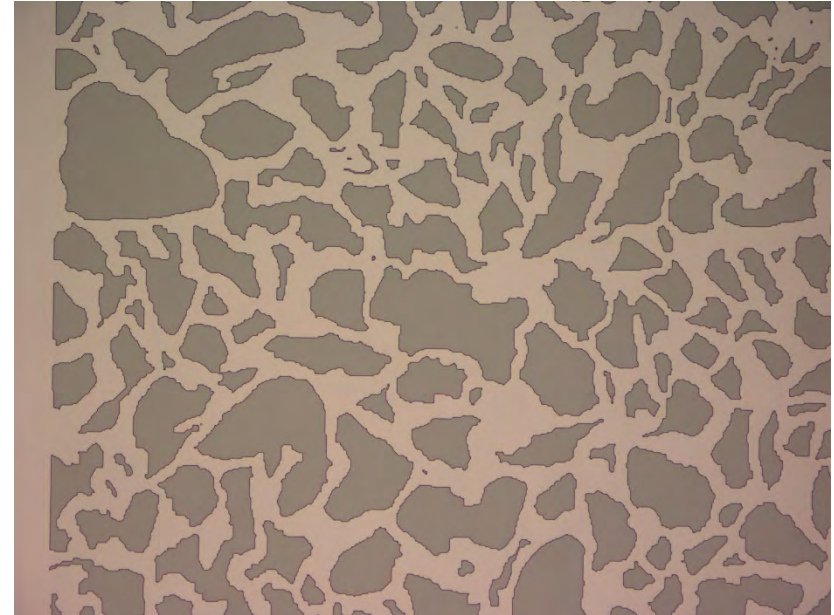

*A photo of a sample micromodel fabricated at MMF employing standard photolithography and reactive-ion etching (RIE)*

Yaofa Li, PI and Assistant Professor, Department of Mechanical and Industrial Engineering. Micromodels designed and fabricated at Montana Microfabrication Facility.

*National Research Priority: NAE Grand Challenge-Develop Carbon Sequestration Methods*

# Targeted NanoSpheres (TNS): An Effective Therapeutic Platform for Cancer Treatment

NanoValent and CHLA have developed a novel targeted nanoparticle called Targeted NanoSpheres or TNS. TNSs are formulated to give robust shells with large carrying interiors. The shells are filled with cancer drugs and decorated with antibodies that make them sticky to tumor cells. Once administered to the patient, the TNSs leave the blood circulation and deliver their drug payload to the growing tumor. By delivering more drug on target, the overall toxicity to healthy tissues is minimized. This technology has the potential as an effective delivery vehicle for virtually any type of cancer for which a suitable tumor cell surface antigen is present. In addition, a variety of small molecules chemotherapeutics payloads as well as oligonucleotides, such as siRNA, ASOs, and mRNA, have been successfully incorporated and effectively delivered with documented superior anti-tumor effect.

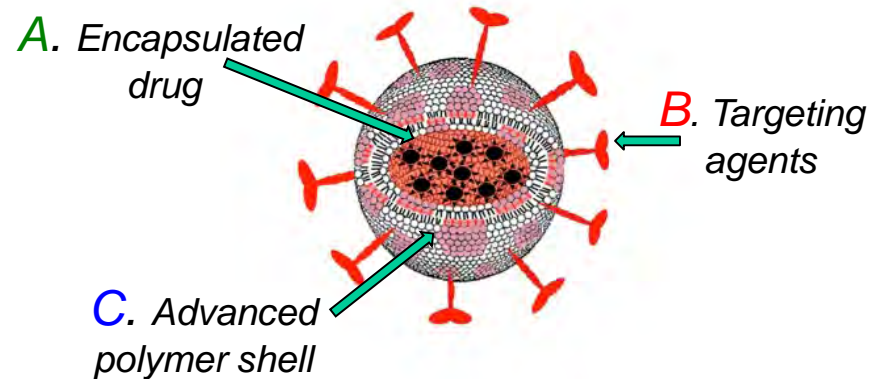

*Schematic of an antibody targeted, drug loaded TNS split to show contents (top). Negative stained transmission EM image of a TNS particle (right).*

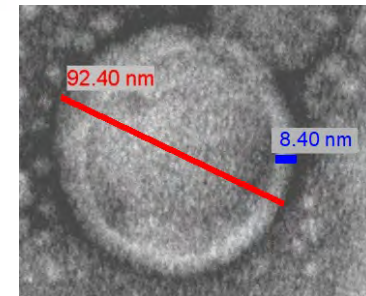

J.O. Nagy, T. Triche, H. Kang, B. Upton, R. Upton, NanoValent Pharmaceuticals, Inc., Children's Hospital Los Angeles. Work performed at Montana State University, MONT facility.

Funding by NSF SBIR grants (IIP-1143342 , II-1330140) NIH NCI STTR and SBIR grants (1R41CA203457-01A1, 1R44 CA233128-01).

*National Research Priority: NAE Grand Challenge-Engineer Better Medicines*



# Acoustofluidic Synthesis of Particulate Nanomaterials

Acoustofluidic platform synthesizes nanoparticles and nanomaterials in a controllable, reproducible manner through acoustic-streaming-based active mixing of reagents

Allows for the dynamic control of reaction conditions by adjusting the strength of the acoustic streaming

Synthesis of diverse nanoparticles/nanomaterials: polymeric nanoparticles, chitosan nanoparticles, organic–inorganic hybrid nanomaterials, metal–organic framework biocomposites, and lipid-DNA complexes

Platform flexibility in establishing various reaction conditions enables the synthesis of versatile nanoparticles and nanomaterials with prescribed properties

P-Hsun Huang and Tony Jun Huang, Dept. of Mechanical Engineering and Materials Science, Duke University. Work performed at Duke's Shared Materials Instrumentation Facility.

Work supported by the NIH (R01GM132603, R44HL126441, R44GM125439, R01GM127714, R33CA223908) and NSF (ECCS-1807601). *Adv. Sci.*, 6, 365 (2019).

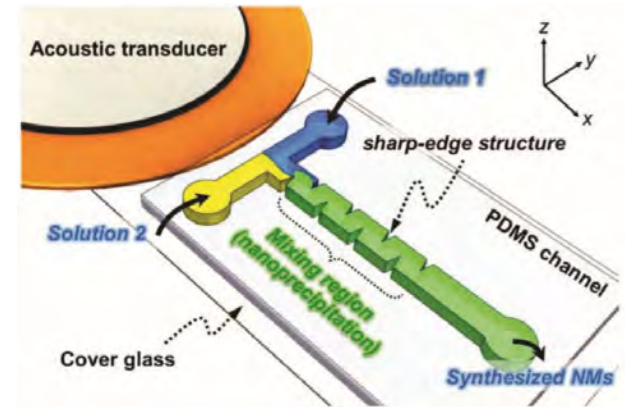

The acoustofluidic synthesis device is composed of a microfluidic channel with multiple pairs of sharp-edge structures. When flowing through the channel, Solutions 1 and 2 are rapidly mixed in the presence of the acoustic streaming effect.



SEM images of nanohybrids synthesized by mixing tetrathiafulvalene (TTF) and  $\text{HAuCl}_4$  solutions at different flow rate ratios

National Research Priority: NAE Grand Challenge-Making Better Medicines

# Microbial Corrosion of Different Strains of Sulfate Reducing Bacteria

Microbially influenced corrosion (MIC) describes the change in material degradation due to the presence and activity of various microbes and biofilms. MIC has been associated with worldwide damage costs ranging to many billions of US\$ annually.

Many laboratory studies of MIC utilize sulfate reducing bacteria (SRB) as the microbe of interest. However there are numerous strains of SRB with potentially different abilities to affect corrosion. This work investigated the corrosion of 4 different SRB strains.

To assist with these studies a range of ICAL equipment including SEM, EDS, XRD, XPS and Auger spectroscopy were utilized to provide key biofilm, metallurgical and chemical information.



*SRB Desulfovibrio vulgaris in biofilm formed on the surface of a carbon steel sample*

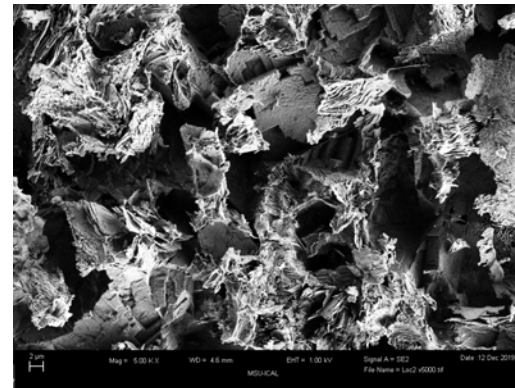

*Localized corrosion of carbon steel when tested with SRB Desulfovibrio indonesiensis*

Scott Wade (Swinburne University, Australia), together with ICAL and CBE staff. Work performed at MONT facility ICAL.

Funded through Swinburne University sabbatical scheme and the Defence Materials Technology Centre.

*National Research Priority: NAE Grand Challenge-Restore and Improve Urban Infrastructure*

# Associates of Applied Science in Nanotechnology for Rio Salado Collage

NCI-SW is collaborating with Rio Salado College (part of the Maricopa County Community College District) to host advanced laboratory curriculum for students enrolled in their two-year, 62 credit AAS degree in Nanotechnology which contains an 18 credit Certificate of Completion. The stackable credentials offer options to students at different preparation levels. Since its launch in Spring 2017, 12 students have graduated from the AAS Nanotechnology program. The program has attracted the attention of major technology manufacturers including Intel Corporation who are actively hiring technicians with two-year STEM degrees through online recruitment sites. Dr. Mary White has been able to follow up with eight of the graduates who have progressed their careers as follows:

- Graduate school at Johns Hopkins University
- Intel Manufacturing Technician in Arizona
- Production Technician at Cantel Medical Corp.
- Arizona State University - Chemical Engineering BS
- Learning Designer Associate at Arizona State University
- BS Eng. Applied Electronics at New Mexico State University
- Serial entrepreneur bringing a nano product to market
- Process Engineering Technologist at Applied Materials



## Intel is Hiring Manufacturing Technicians

Join the team who is the heart of Intel's mission to build the world's best processors. Work at our high-tech fabrication facilities worldwide, using the most advanced manufacturing processes and tools. If you enjoy working with the latest technology in a rewarding, fast-paced environment, a career in manufacturing at Intel may be for you.

*Intel is currently hiring hundreds of Manufacturing Technicians and Specialists. They are advertising the need for technicians with certificate and two-year degrees through online ads such as this.*

R. Vaughn, Rio Salado College and R. Tsui and T. J. Thornton, ASU.



*National Research Priority: NAE Grand Challenge-Advance Personalized Learning*

---

## ***NNI Signature Initiatives***



# Plasmon-Enhanced Chemical Sensing and Conversion using Copper Selenide Nanoparticles

There has been increasing interest in non-noble metal plasmonic to reduce cost. As these materials come online, it is important to understand and assess their ability to generate comparable or complementary plasmonic properties to their noble metal counterparts, including as both sensing and photoredox materials. This work studies plasmon-driven chemistry on degenerately doped copper selenide ( $\text{Cu}_{2-x}\text{Se}$ ) nanoparticles. In particular, we observe plasmon-driven dimerization of 4-nitrobenzenethiol to 4,4'-dimercaptoazobenzene on  $\text{Cu}_{2-x}\text{Se}$  surfaces with yields comparable to those observed from noble metal nanoparticles. Overall, the results indicate that doped semiconductor nanoparticles are promising for light-driven chemistry technologies.

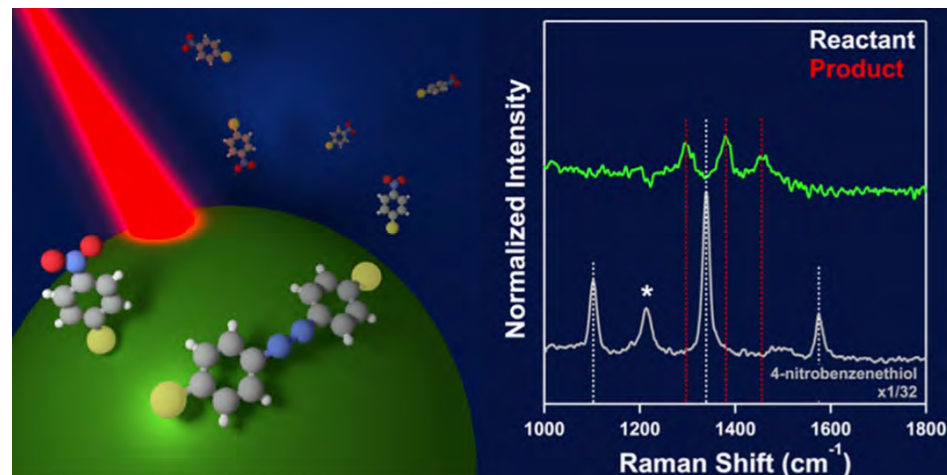

*Copper selenide particles are found to catalyze the plasmonic conversion of organic molecules in a manner similar to more expensive noble metals such as Au and Pt.*

X.Y. Gan, E.L. Keller, C.L. Warkentin, S. Crawford, R.R. Frontiera, J.E. Millstone. Work performed at Minnesota's Nano Center.

*Nano Letters*, 19, 4, 2384-2388, 2019.

*National Research Priority: NNI Signature Initiative-Nanotechnology for Sensors and Sensors for Nanotechnology*

# Gamma Ray Damage in Ga<sub>2</sub>O<sub>3</sub> Schottky Rectifiers

Ga<sub>2</sub>O<sub>3</sub> Schottky rectifiers consisting of thick (10 μm) epitaxial drift regions on conducting substrates are shown to have a high tolerance to <sup>60</sup>Co gamma ray irradiation. This is due to the low carrier removal rate of <math><1\text{ cm}^{-1}</math> for gamma rays, which contrasts to values of 300–500 cm<sup>-1</sup> for MeV protons and alpha particles in the same rectifier structures. Changes in diode ideality factor, Schottky barrier height, on-resistance, on-off ratio, and reverse recovery time are all minimal for fluences up to  $2 \times 10^{16}\text{ cm}^{-2}$ . These results are consistent with previous reports on gamma-irradiation of Ga<sub>2</sub>O<sub>3</sub> metal oxide semiconductor field effect transistors where changes were ascribed to damage in the gate dielectric and not to the Ga<sub>2</sub>O<sub>3</sub> itself.

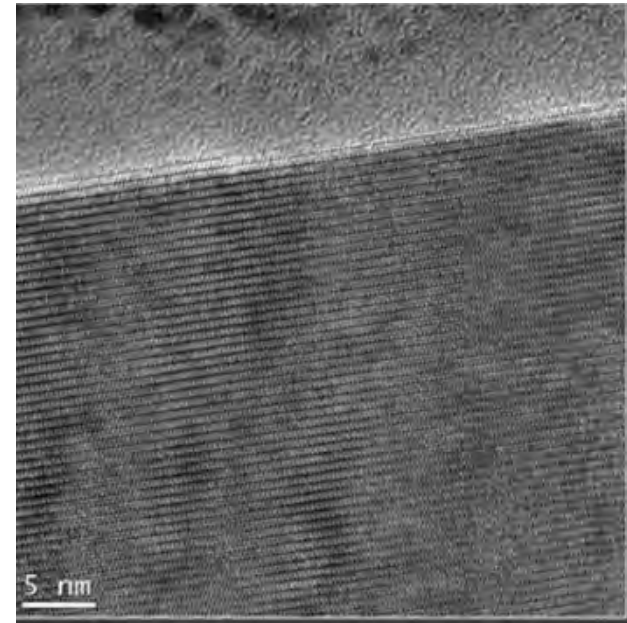

*High resolution TEM of the upper section of the Ga<sub>2</sub>O<sub>3</sub> layer. The bright lines show the surface of the epi layer*

S. J. Pearton, Department of Materials Science and Engineering, University of Florida. Work performed at NCI-SW.

*ECS Journal of Solid State Science and Technology*, vol. 8(7), pp. 3041-3045, February 2019.

*National Research Priority: NNI Signature Initiative-Nanoelectronics 2020 and Beyond*

# Phonon Dissipation in Nanostructured Semiconductor Devices

As aggressive scaling pushes device dimensions further into the nanometer regime, heat dissipation continues to impose strict limits on their performance. New device geometries, such as gate-all-around (GAA) nanowires and junction-less (JL) transistors, offer improved electrostatic control that is needed for the sub- 10-nm regime. However, the reduced device dimensions also diminish thermal conductivity, introduce additional thermal resistance at interfaces, and thus exacerbate the self-heating problem. We anticipate that coupled electrothermal simulation, based on the full-band Monte Carlo approach for electrons and phonons will continue to guide the design of JL and GAA devices.

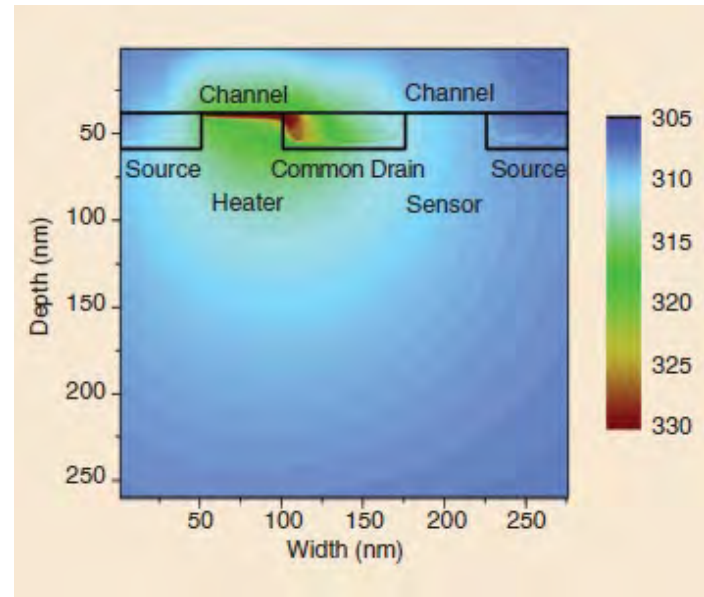

*Simulated optical phonon temperatures in a coupled CMOS heater-thermometer sensor pair.*

M. Mohamed, MIT Lincoln Labs and Dragica Vasileska, Arizona State University. Work performed at NCI-SW.

*IEEE Nanotechnology Magazine*, vol. 13, no. 4, pp. 6-17, Aug. 2019.

*National Research Priority: NNI Signature Initiative-Nanoelectronics 2020 and Beyond*

# Edge passivation of MoS<sub>2</sub> monolayers

Sodium bromide surfactant relaxes in-plane strains by chemically passivating edges of growing molybdenum disulfide crystals.

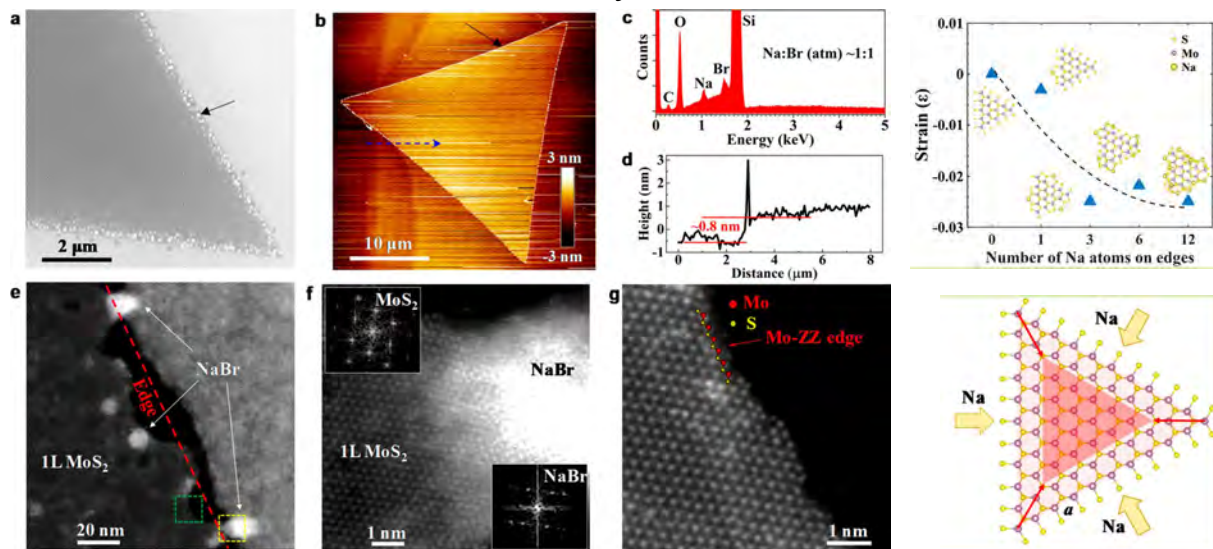

*“The shared facilities are helping us develop new low dimensional materials and study the properties and growth mechanisms, which could be potentially used to build disruptive technologies in energy (for batteries and electrocatalysts), sensors, and electronics.”*



Xufan Li, Honda Research Institute USA. Work performed at Stanford Nano Shared Facilities, nano@stanford site.

This work was supported by NSF Award # ECCS-1542152. ACS Nano (2020) doi: 10.1021/acsnano.0c00132

*National Research Priority: NNI Signature Initiative-Nanoelectronics 2020 and Beyond*



---

## ***Other National Research Priorities***

# Aerosol Jet Printing of Biological Inks

Printing is a promising method to reduce cost of fabricating biomedical devices. Inkjet printing (IJP) is limited to printing inks with narrow range of viscosities and densities

Aerosol jet printing (AJP) functions via aerosolization of ink by ultrasonication or pneumatic pressure and offers increased versatility compared to IJP

Highly sensitive immunoassays were printed via AJP, retained biofunctionality, and exhibited sensitivities in the pg/ml range

Nick Williams and Aaron Franklin, Dept. of Electrical and Computer Engineering, Duke University. Work performed at Duke's Shared Materials Instrumentation Facility.

Work supported by the DoD Congressionally Directed Medical Research Program (W81XWH-17-2-0045) and NIH (1R21HL141028). *Biofabrication*, 12 (2020).

*National Research Priority: White House FY2022, Administration R&D Budget Priorities-Diagnostic, Vaccine, and Therapeutic R&D*

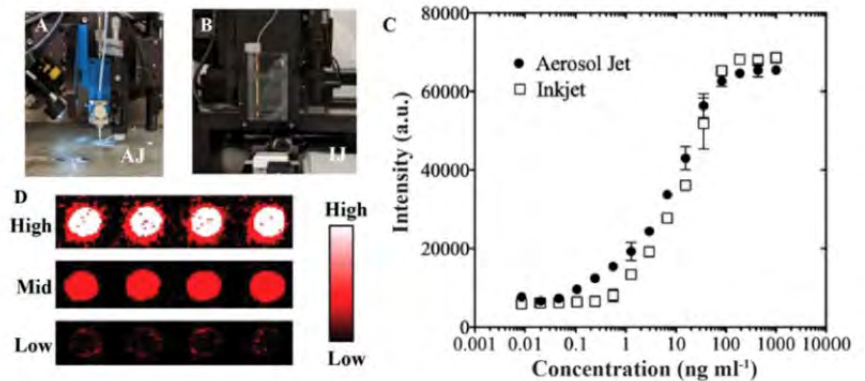

*Printed immunoassay comparing AJP and IJP*

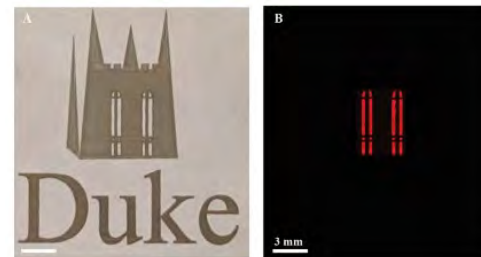

*Optical photograph of Duke Chapel printed with Ag nanowires (left) and streptavidin printed windows (right)*

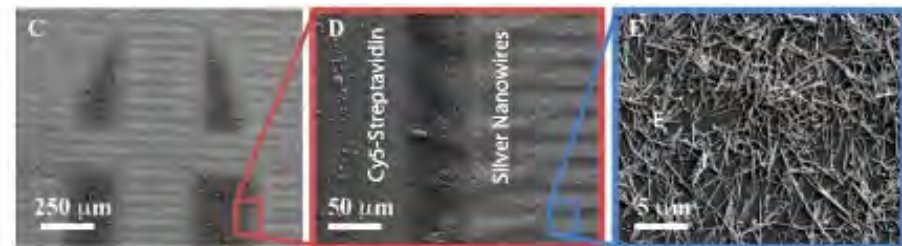

*SEM images of printed streptavidin and silver nanowires*

# Characterization of particles emitted from aerosolized consumer products

This work focuses on understanding potential inhalation risks and hazards during the use of common aerosolized consumer products. Four de-identified consumer aerosolized cosmetic aerosols (AA4, AA8, S1, and S4) were assessed. Aerosols were generated, monitored and sampled using a novel aerosol generation system complete with aerosol monitoring instrumentation and animal exposure pods for in vivo toxicological evaluations. Aerosols were sampled onto aluminum substrates and evaluated using transmission electron microscopy coupled with energy dispersive X-ray spectroscopy (TEM-EDX)(Figure 1). Aerosols were multimodal consisting of micro-sized particles decorated with nanoparticles containing primarily titanium and iron.

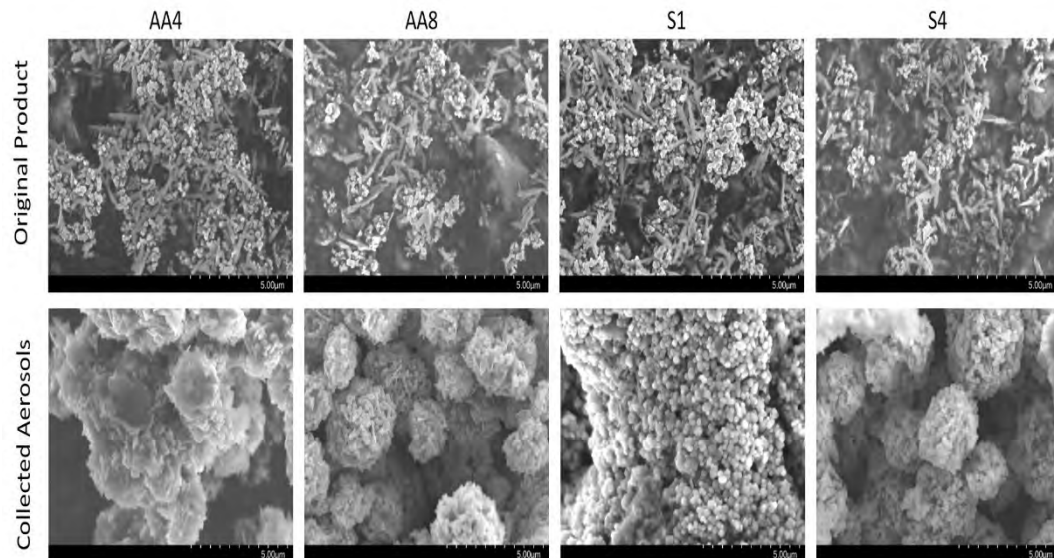

Figure 1. TEM micrograph consumer product aerosols emitted from aerosolized nano-enabled cosmetics.

Pearce, K.M., Goldsmith, W.T., Greenwald, R., Yang, C., Mainelis, G. & Wright, C., Dept. of Population Health Sciences, School of Public Health, Georgia State University, IES techno, Institute for Electronics and Nanotechnology, Georgia Institute of Technology, Dept. of Environmental Sciences, Rutgers University. TEM-EDX work completed at IEN - Georgia Institute of Technology.

*Inhalation Toxicology*, DOI: 10.1080/08958378.2019.1685613

*National Research Priority: Earth System Predictability and Meteorology (Federal R&D Research Priorities)*

# Fabrication of Silicon Carbide Thin Films for Permeation Studies

**Objective:** To deposit and confirm the quality of silicon carbide (SiC) coatings on stainless steel substrates.

**Motivation:** SiC coatings have been found to control hydrogen permeation into stainless steel structures but require uniform coverage with minimal cracking to be successful.

**Results:** SiC films with no tensile cracks or delamination were successfully deposited. Indentation showed high surface hardness and XPS confirmed uniformity of film chemistry.

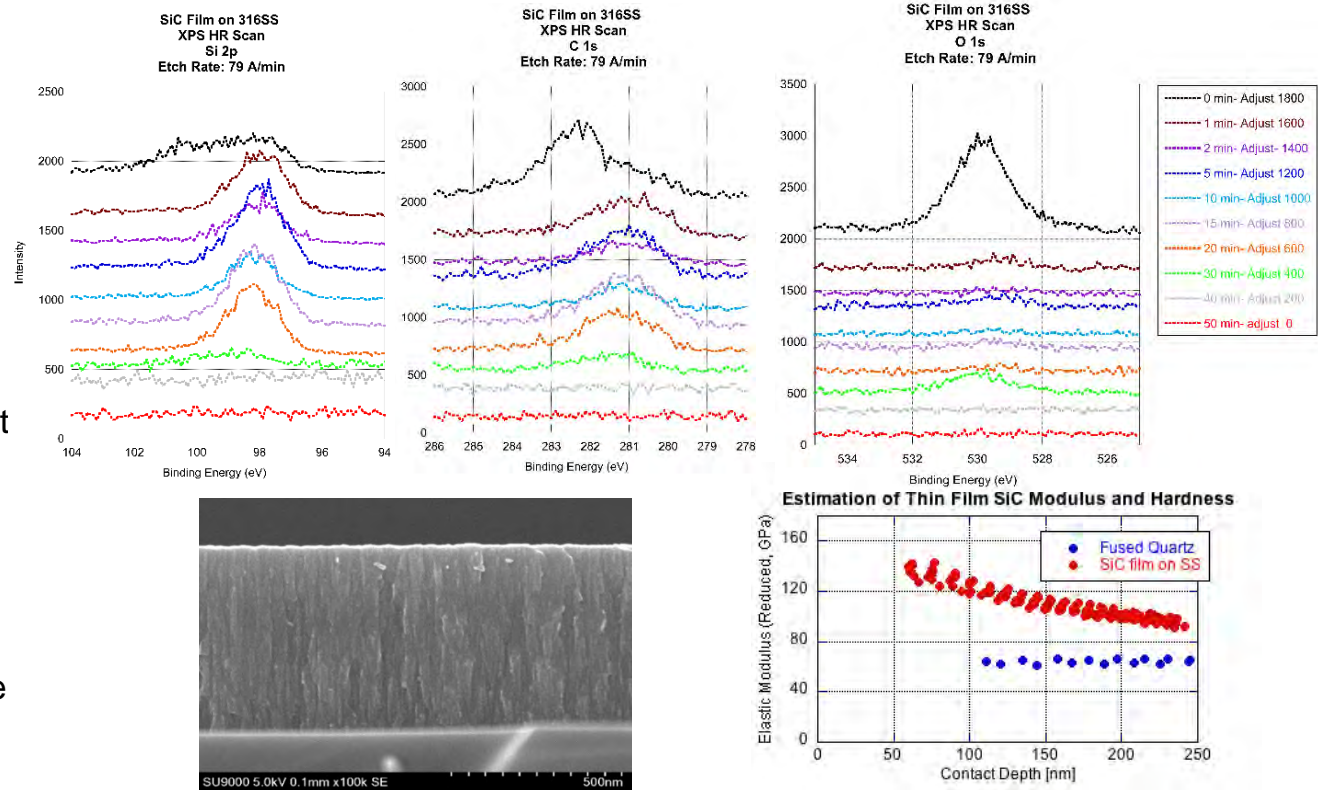

M. Piness, M. S. Kennedy, and G. J. Pataky, Mechanical Engineering, Clemson University. Work partially performed at Georgia Tech's Institute for Electronics and Nanotechnology.

Funding through Savannah River National Laboratory.

*National Research Priority: Advanced Manufacturing (Federal R&D Research Priorities)*



# Catalytic Oxidation of a Model Volatile Organic Compound Studied via Ambient-Pressure X-ray Photoelectron Spectroscopy

Isopropyl alcohol (IPA) is a common volatile organic compound (VOC) and  $\text{SnO}_2$  has been proposed as an inexpensive/stable catalyst for its oxidation. To better understand IPA reaction mechanisms with  $\text{SnO}_2$  we have used ambient-pressure x-ray photoelectron spectroscopy (AP-XPS) and *in situ* mass spectrometry. Using AP-XPS we were able to determine the chemical states of the adsorbed species on  $\text{SnO}_2$  and  $\text{SnO}_2$  reduction under numerous experimental conditions. We found that both the IPA/ $\text{O}_2$  ratio and sample temperature strongly influence reaction chemistries. Results suggest oxidation of IPA occurs via a Mars–van Krevelen mechanism on stoichiometric  $\text{SnO}_2$ .

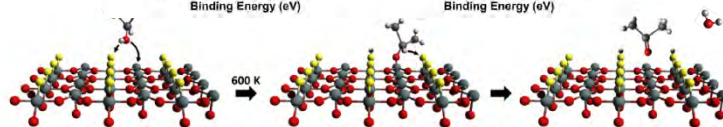
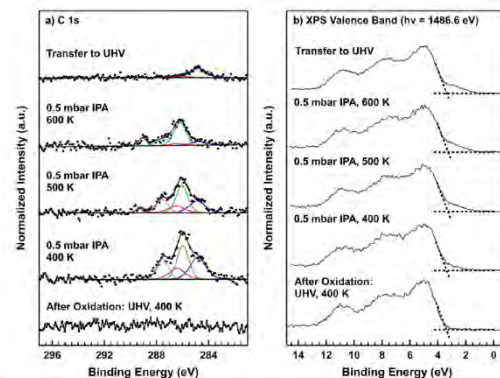

*Top: C 1s and VB AP-XPS spectra obtained at 0.5 mbar IPA at several temperatures. C 1s spectra indicate change in IPA chemical stage for adsorbed species and VB spectra indicate reduction of  $\text{SnO}_2$  during reaction. Bottom: Proposed mechanism with IPA adsorption, reaction, and desorption of acetone and water.*

J. Trey Diulus, Radwan Elzein, Rafik Addou, Gregory S. Herman, Oregon State University Chemical, Biological, and Environmental Engineering. Work performed in part at APSCL of the NNI site.

*J. Chem. Phys.* (2020), doi: [10.1063/1.5138923](https://doi.org/10.1063/1.5138923).

# Virtual Nanoscience Professional Development Workshop for High School Teachers

- Reach: 16 teachers impacting over 1,130 students per year
- Awarded teachers continuing education credit
- Provided practical methods for including nanoscience concepts in their curriculum
- Teachers received a package of educational laboratory supplies
- Mix of synchronous and asynchronous content
- Highlighted various online learning technology platforms including Zoom, Google Meet, Google Classroom, Canvas, and Slack
- Discussions focused on how activities could be held in an in person, physically-distant classroom, but also virtually
- Building on prior NSF supported work - many of the activities were developed by the NNIN (ECCS-0335765), NISE-Net (DR-0532536 and DRL0940143), & CNS (SES-0937591)

## Assessment: Pre/Post Test (0 - Strongly Disagree to Strongly Agree - 3)

*I am confident in my ability to teach a nanoscience lesson in my classroom.*

- Change: +1.1 (Pre-survey: 1.3, Post-survey: 2.4)

*I am interested in teaching a lesson on nanoscience in my classroom.*

- Change: +0.3 (Pre-survey: 2.4, Post-survey: 2.7)

*I have the resources needed to teach a nanoscience lesson in my classroom.*

- Change: +1.7 (Pre-survey: 1.1, Post-survey: 2.8)

*I am confident in my understanding of nanoscience.*

- Change: +0.8 (Pre-survey: 1.3, Post-survey: 2.1)

*Would you recommend this workshop to other teachers? 100% Yes, 0% No*

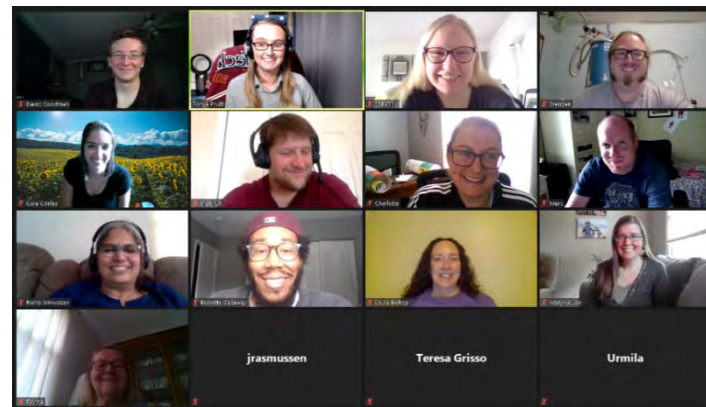

## Feedback

- *"The content is excellent for providing cross-curricular learning opportunities and career explorations. I enjoyed how some of the lessons related and integrated math with science. This is so important since we, as teachers, repeatedly hear that trite question, "When are we ever going to use this stuff?!"*
- *"I think this workshop is a good way to learn a relevant topic in science that is only going to continue to become more relevant and the more teachers that learn this topic the more opportunities students will have to pursue a career in this field."*
- *"Learning to navigate these online tools was extremely beneficial. Experiencing Canvas has been extremely important since I will have to use it in my division."*
- *"You guys did an excellent job in integrating the use of online tools and resources into the Nanoscience workshop!!! Thank you!"*

# Remote Nanoscience Summer Institute for Middle School Teachers

- Nanoscience Summer Institute for Middle School Teachers was a 4 day in-person workshop, 15 teachers (5 from Title I schools)
- Fully remote in June 2020, with remote Fall follow up
  - ◆ Guest lectures & remote tours
  - ◆ Activity kits mailed in advanced
- Invited past NanoSIMST teachers to as Lead Teachers to support with great results
  - ◆ 4 of 14 teachers this year have formally implemented
  - ◆ 7 alumni have reached out with remote tour / guest lecture requests
- Plan to implement program evaluation in 2021

This work was supported by NSF Award # ECCS-2026822.

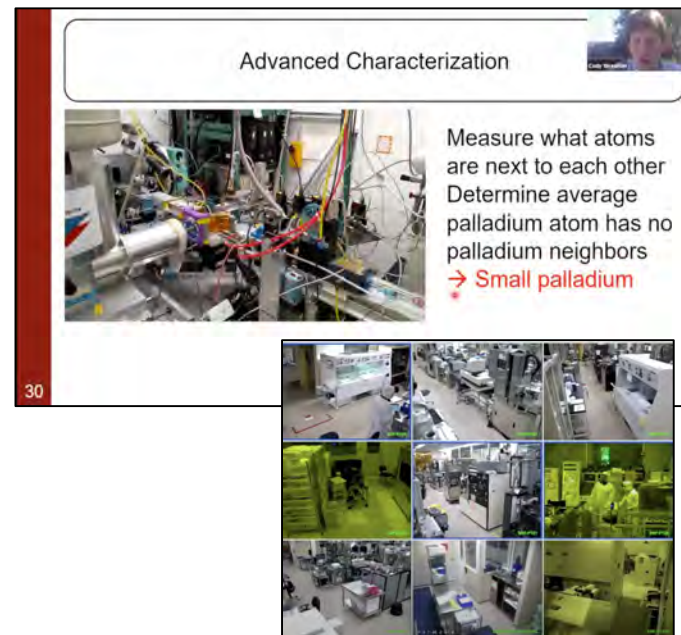
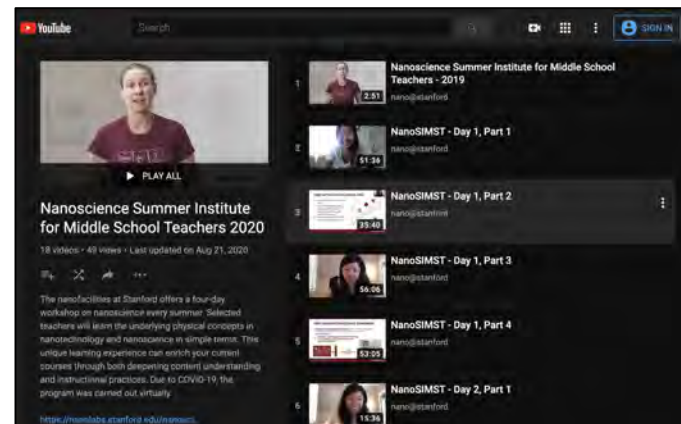



# Online Education

Training content is hosted online through YouTube and an edX-based platform. Content is structured to start with fundamental knowledge on general fabrication and characterization techniques, and is refined to Stanford-specific tools and their operating procedures

- 138 videos uploaded this year alone on YouTube
- Fully remote XPS training online (with 9 videos & quizzes for each section)
- Uploaded Electron Beam Lithography module online
- About 3,000 users total
- 102 countries represented; Top countries: 18% US, 14% India, 4% Indonesia

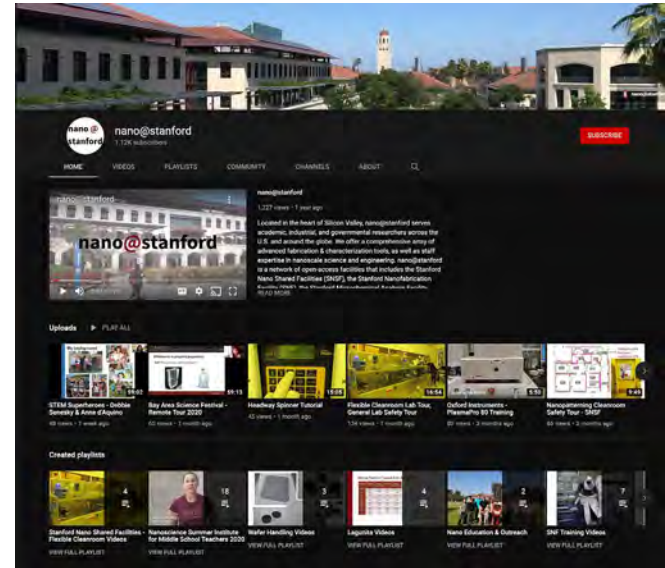

This work was supported by NSF Award # ECCS-2026822.

